



# Operating Instructions and Parts Manual

## 6-inch Woodworking Jointer

Models JJ-6CSDX, JJ-6HHDX



JJ-6CSDX shown

**JET**  
427 New Sanford Road  
LaVergne, Tennessee 37086  
Ph.: 800-274-6848  
[www.jettools.com](http://www.jettools.com)

**Part No. M-708457DX**  
ED 6 09/2023  
ECR 170412164655  
Copyright © 2018 JET



## 1.0 IMPORTANT SAFETY INSTRUCTIONS

### WARNING – To reduce risk of injury:

1. Read and understand the entire owner's manual before attempting assembly or operation.
2. Read and understand the warnings posted on the machine and in this manual. Failure to comply with all of these warnings may cause serious injury.
3. Replace the warning labels if they become obscured or removed.
4. This Woodworking Jointer is designed and intended for use by properly trained and experienced personnel only. If you are not familiar with the proper and safe operation of a woodworking jointer, do not use until proper training and knowledge have been obtained.
5. Do not use this Jointer for other than its intended use. If used for other purposes, JET disclaims any real or implied warranty and holds itself harmless from any injury that may result from that use.
6. Always wear approved safety glasses/face shields while using this woodworking jointer. Everyday eyeglasses only have impact resistant lenses; they are not safety glasses.
7. Before operating this woodworking jointer, remove tie, rings, watches and other jewelry, and roll sleeves up past the elbows. Remove all loose clothing and confine long hair. Non-slip footwear or anti-skid floor strips are recommended. Do **not** wear gloves.
8. Wear ear protectors (plugs or muffs) during extended periods of operation.
9. Do not operate this machine while tired or under the influence of drugs, alcohol or any medication.
10. Make certain the switch is in the **OFF** position before connecting the machine to the power source.
11. Make certain the machine is properly grounded.
12. Make all machine adjustments or maintenance with the machine unplugged from the power source.
13. Remove adjusting keys and wrenches. Form a habit of checking to see that keys and adjusting wrenches are removed from the machine before turning it on.
14. Keep safety guards in place at all times when the machine is in use. If removed for maintenance purposes, use extreme caution and replace the guards immediately.
15. Make sure the woodworking jointer is firmly secured to the floor or bench before use.
16. Check damaged parts. Before further use of the machine, a guard or other part that is damaged should be carefully checked to determine that it will operate properly and perform its intended function. Check for alignment of moving parts, binding of moving parts, breakage of parts, mounting and any other conditions that may affect its operation. A guard or other part that is damaged should be properly repaired or replaced.
17. Provide for adequate space surrounding work area and non-glare, overhead lighting.
18. Keep the floor around the machine clean and free of scrap material, oil and grease.
19. Keep visitors a safe distance from the work area. **Keep children away.**
20. Make your workshop child proof with padlocks, master switches or by removing starter keys.
21. Give your work undivided attention. Looking around, carrying on a conversation and “horse-play” are careless acts that can result in serious injury.
22. Maintain a balanced stance at all times so that you do not fall or lean against the cutterhead or other moving parts. Do not overreach or use excessive force to perform any machine operation.
23. Use the right tool at the correct speed and feed rate. Do not force a tool or attachment to do a job for which it was not designed. The right tool will do the job better and safer.
24. Use recommended accessories; improper accessories may be hazardous.

25. Maintain tools with care. Keep knives sharp and clean for the best and safest performance. Follow instructions for lubricating and changing accessories.
26. Turn off the machine before cleaning. Use a brush or compressed air to remove chips or debris — do not use your hands.
27. Do not stand on the machine. Serious injury could occur if the machine tips over.
28. Never leave the machine running unattended. Turn the power off and do not leave the machine until it comes to a complete stop.
29. Before turning on machine, remove all extra equipment such as keys, wrenches, scrap, stock, and cleaning rags away from the machine.
30. At all times hold the stock firmly. Always use a hold-down or push block when surfacing stock less than 12 inches long, or 3 inches wide, or 3 inches thick.
31. Do not perform jointing operations on material shorter than 8", narrower than 3/4" or less than 1/4" thick.

32. The hands must never be closer than 3 inches to the cutterhead (see Figure).
33. Never apply pressure to stock directly over the cutterhead. This may result in the stock tipping into the cutterhead along with the operator's fingers. Position hands away from extreme ends of stock, and push through with a smooth, even motion. Never back workpiece toward the infeed table.



34. Do not make cuts deeper than 1/2" when rabbeting. On other cuts such as edging, surfacing, etc., depth of cut should not be over 1/8" to avoid overloading the machine and to minimize chance of kickback.
35. To avoid kickback, the grain must run in the same direction you are cutting. Before attempting to joint, or plane, each work piece must be carefully examined for stock condition and grain orientation.
36. When working with a swirl grain wood or burls, making it necessary to plane against the grain, use a lesser depth of cut and a slow rate of feed.
37. Move the hands in an alternate motion from back to front as the work continues through the cut. Never pass the hands directly over the cutter knife. As one hand approaches the knives remove it from the stock in an arc motion and place it back on the stock in a position beyond the cutter knife.

Familiarize yourself with the following safety notices used in this manual:

**CAUTION** This means that if precautions are not heeded, it may result in minor injury and/or possible machine damage.

**WARNING** This means that if precautions are not heeded, it may result in serious injury or possibly even death.

**- - SAVE THESE INSTRUCTIONS - -**

### 1.1 On-Off Switch Padlock

The jointer is equipped with a push-button switch that will accept a safety padlock (not included; see Figure 1-2). To safeguard your machine from unauthorized operation and accidental starting by young children, the use of a padlock is highly recommended.

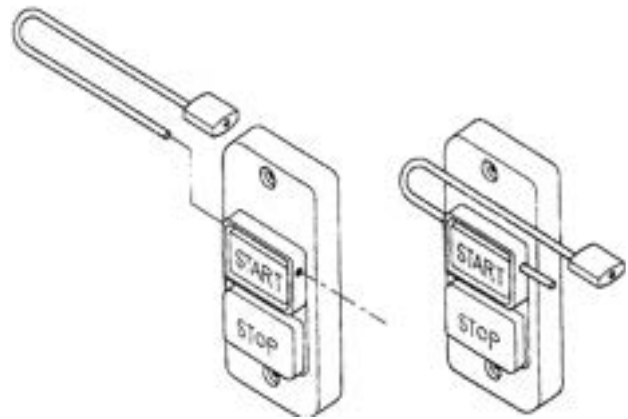

Figure 1-2: On-Off Switch Padlock

## 2.0 Introduction

This manual is provided by JET covering the safe operation and maintenance procedures for Models JJ-6CSDX and JJ-6HHDX Jointers. This manual contains instructions on installation, safety precautions, general operating procedures, maintenance instructions and parts breakdown. This machine has been designed and constructed to provide consistent, long-term operation if used in accordance with instructions set forth in this manual. If there are any questions or comments, please contact your local supplier or JET, or visit our web site: [www.jettools.com](http://www.jettools.com).

Register your product using the mail-in card provided, or register online:  
<http://www.jettools.com/us/en/service-and-support/product-registration/>

## 3.0 Table of Contents

1.0	IMPORTANT SAFETY INSTRUCTIONS .....	2
2.0	Introduction.....	4
3.0	Table of Contents .....	5
4.0	Specifications .....	6
5.0	Unpacking.....	7
6.0	Assembly .....	8
7.0	Electrical Connections.....	11
8.0	Adjustments.....	12
9.0	Operating Controls .....	18
10.0	Operation.....	19
11.0	Maintenance .....	21
12.0	Lubrication.....	23
13.0	Troubleshooting.....	24
14.0	Optional Accessories.....	26
15.0	Replacement Parts .....	26
15.1.1	Fence Assembly (All Models) – Exploded View.....	27
15.1.2	Fence Assembly (All Models) – Parts List .....	28
15.2.1	Stand Assembly, JJ-6CSDX – Exploded View .....	29
15.2.2	Stand Assembly, JJ-6CSDX – Parts List .....	30
15.3.1	Stand Assembly, JJ-6HHDX only – Exploded View.....	31
15.3.2	Stand Assembly, JJ-6HHDX only – Parts List .....	32
15.4.1	Bed Assembly (All models) – Exploded View .....	33
15.4.2	Bed Assembly (All models) – Parts List .....	34
15.5.1	Cutterhead, JJ-6CSDX – Exploded View.....	35
15.5.2	Cutterhead JJ-6CSDX – Parts List .....	35
15.6.1	Cutterhead, JJ-6HHDX – Exploded View .....	36
15.6.2	Cutterhead, JJ-6HHDX – Parts List .....	36
16.0	Wiring Diagrams (All Models).....	37
17.0	Warranty and Service .....	38

## 4.0 Specifications

Model	JJ-6CSDX	JJ-6HHDX
Stock Number – Bed and Stand Kit.....	708457DXK.....	708466DXK
Stock Number – Bed Assembly.....	708457DXJ.....	708466DXJ
Stock Number Stand .....	708457DXS.....	708466S
Cutting Capacity .....	6-1/16"W x 1/8"D.....	6"W x 1/8"D
Cutterhead Speed .....	6000 RPM.....	6000 RPM
Number of Knives .....	3.....	27 four-sided inserts
Number of Rows in Cutterhead .....	n/a.....	4
Max Stock Removal.....	1/2".....	1/2"
Rabbeting Capacity*.....	1/2".....	n/a
Rabbit Ledge.....	3-1/8" x 8-3/4".....	n/a
Table Surface .....	7-3/8"W x 56"L x 31-1/4"H.....	7-3/8"W x 56"L x 31-1/4"H
Fence.....	3-7/8"H x 32-3/4"L.....	3-7/8"H x 32-3/4"L
Knife Size .....	6-1/16" x 3/4" x 5/64"T.....	15 x 15 x 2.5T mm
Fence Tilt.....	45°L, 45°R.....	45°L, 45°R
Positive Stops.....	45°L, 90°, 45°R.....	45°L, 90°, 45°R
Motor .....	1HP, 1PH, 60Hz, 13/6.5A, 115/230V.....	1HP, 1PH, 60Hz, 13/6.5A, 115/230V
	pre-wired 115V	pre-wired 115V
Net Weight.....	237 lbs.....	237 lbs
Shipping Weight .....	258 lbs.....	258 lbs

L = length, W = width, H = height

n/a = not applicable

\* See 10.4 Rabbeting, page 20 for proper rabbeting operation.

The above specifications were current at the time this manual was published, but because of our policy of continuous improvement, JET reserves the right to change specifications at any time and without prior notice, without incurring obligations.

## 5.0 Unpacking

This unit is shipped in two cartons. Open both cartons and check for shipping damage. Report any damage immediately to your distributor and shipping agent. Do not discard any shipping material until the Jointer is assembled and running properly.

Compare the contents of your cartons with the following parts list to make sure all parts are intact. Missing parts, if any, should be reported to your distributor. Read the instruction manual thoroughly for assembly, maintenance and safety instructions.

Refer to Figures 5-1, 5-2, 5-3.

### Stand Carton

- 1 Stand with Motor
- 1 Stand Cover with Mounting Hardware
- 1 Dust Chute with Mounting Hardware
- 1 Pedestal Switch with Mounting Hardware (*JJ-6HHDX only*)

### Main Unit Carton

- 1 Bed Assembly
- 1 Fence Assembly
- 1 Cutterhead Guard (A)
- 1 Belt Guard (E)
- 1 V-Belt (D)
- 4 1/4-20 x 1/2 Pan Head Screws (L)
- 4 1/4 Flat Washers (M)
- 1 Lock Handle, Flat Washer, and Lock Nut for Fence (G)
- 1 Fence Handle (F)
- 3 Lock Bolts (B)
- 3 3/8" Lock Washers (C)
- 2 Handwheel Assembly (N)
- 2 Push Blocks (K)
- 1 Operating Instructions and Parts Manual
- 1 Warranty Card

### Tools Included for JJ-6CSDX

- 1 12/14mm Open End Wrench (O)
- 1 8/10mm Open End Wrench (P)
- 1 3mm Hex Wrench (Q)
- 1 4mm T-Hex Wrench
- 1 8mm Hex Wrench

### Tools included for JJ-6HHDX:

- 1 12/14mm Open End Wrench (O)
- 1 8/10mm Open End Wrench (P)
- 1 3mm Hex Wrench (Q)
- 1 6mm Hex Wrench
- 2 Star Point Screwdrivers (R)
- 5 Knife Inserts (S)
- 10 Knife Insert Screws (T)

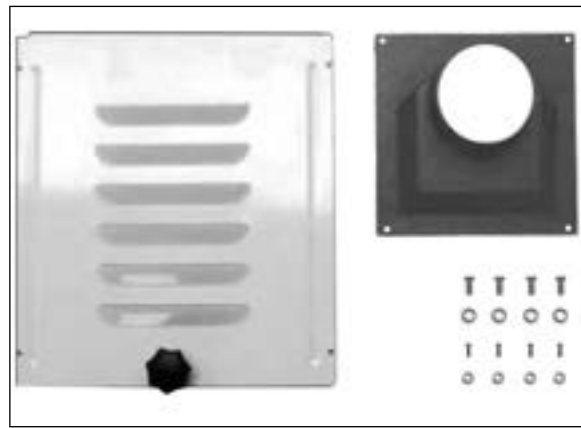
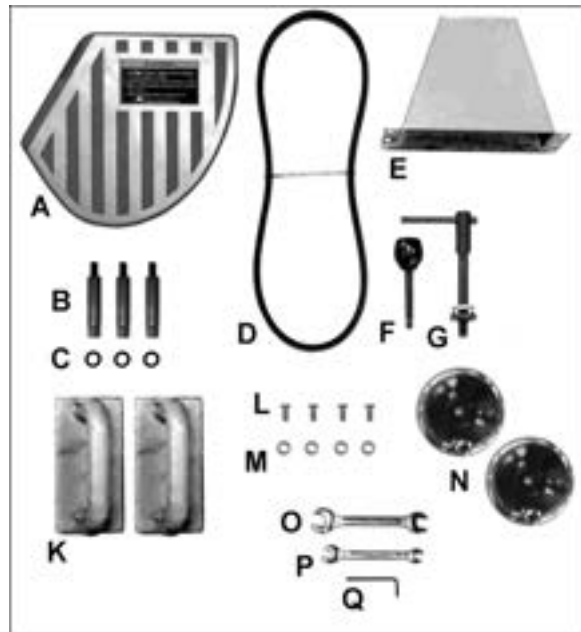

Figure 5-1: Stand carton



5-2: Main Unit Carton



5-3: Tools included for Model JJ-6HHDX only

## 6.0 Assembly

### 6.1 Unpacking and Cleanup

1. Carefully finish removing all contents from both shipping cartons. Compare contents of the shipping cartons with the list of contents above. Place parts on a protected surface.
2. Set packing material and shipping cartons to the side. Do not discard until machine has been set up and is running properly.
3. Clean all rust protected surfaces (bed, fence, etc.) with kerosene or diesel oil. Do not use gasoline, paint thinner, mineral spirits, etc. These may damage painted surfaces.

**WARNING** Cutterhead knives are dangerously sharp! Use extreme caution when cleaning.

4. Apply a thin layer of paste wax to the bright surfaces of the fence and tables to prevent rust.

### 6.2 Installing Bed to Stand

Refer to Figure 6-1:

1. Place bed assembly (A) on top of stand (B). Be sure the identification label (C) on the bed faces the same direction as the switch (D) on the stand.



Figure 6-1

2. Line up two holes in the stand top (E) with holes in the bed assembly by viewing through the access door in rear side of the stand.
3. Attach stand to bed assembly by using two 3/8" lock bolts and lock washers (Figure 6-2). Hand-tighten only at this time.



Figure 6-2

4. Line up the third hole in the stand (F) with the hole in the bed assembly by viewing through the dust chute (G).
5. Install the third 3/8" lock bolt and lock washer through the dust chute (G) to secure the bed to the stand.
6. Tighten all three lock bolts with a 14mm wrench.

### 6.3 Installing Pedestal Switch (JJ-6HDX)

Refer to Figure 6-3:

1. The switch may be installed in either high position or low position to suit the operator. Slide the connection plug through the opening (A) and secure the pedestal switch using two 5/16"x3" screws (C) and 5/16" flat washers (B).
2. Connect the plug of the pedestal switch to the motor plug inside the cabinet.



Figure 6-3



## 6.4 Installing Fence to Bed

Refer to Figure 6-4:

1. Take the lock handle (E), flat washer (F), and lock nut (G) from the carton.
2. Place the fence assembly (A) onto the table (B). Be sure the key stock (D) on the bed lines up with the channel (C) in the fence casting.
3. Place the flat washer (F) on hole (H)\*; insert the lock handle (E) through the fence casting and the table casting.
4. Thread the lock nut (G) onto the lock handle (E). Make sure the tab on the nut faces up and engages the slot in the table casting.

**\*Note:** For rabbeting operations use hole (J).

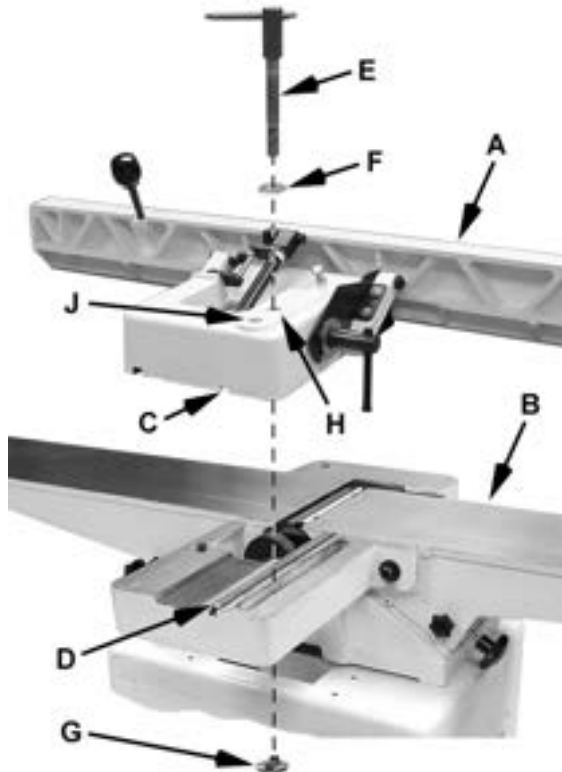

Figure 6-4

## 6.5 Installing the Drive Belt

Refer to Figure 6-5:

1. Place V-belt (A) onto cutterhead pulley (B) and through opening in stand.
2. Pull V-belt down and place onto motor pulley (C).

**Note:** If the belt is difficult to roll on the pulley, loosen the motor mounting screws.

3. Check to make sure that motor pulley and cutterhead pulley are vertically aligned and the V-belt does not contact the sides of the

opening in the base. If the pulleys are not aligned, remove belt and adjust the motor pulley in or out on the motor shaft and then re-attach the belt.

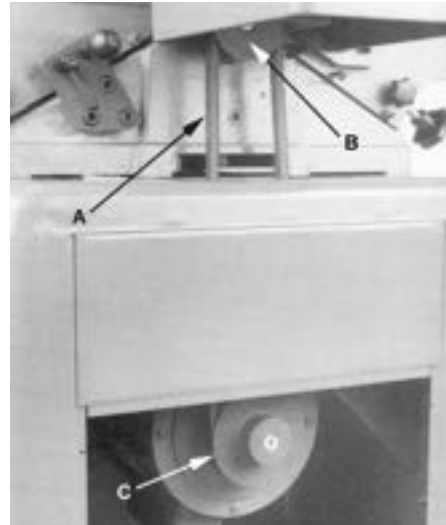

Figure 4

4. The V-belt is properly tensioned when finger pressure on the belt halfway between the two pulleys causes 1/2" deflection (Figure 5). If the belt is too loose, loosen the four motor mount bolts, push down on the motor to tension the V-belt, and tighten the mounting bolts.

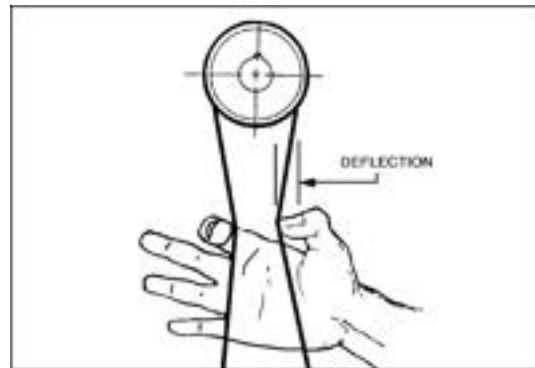

Figure 6-5

5. A new belt may have a tendency to stretch slightly until broken in. After two hours of operation, check belt tension again. Readjust the tension if necessary.

## 6.6 Installing Belt Guard

Refer to Figure 6-6:

1. Place the belt guard (A) over the opening in the stand.
2. Line up the holes in the stand with the holes in the guard.
3. Attach the guard to the stand using four 1/4-20 x 1/2" pan head machine screws (B) and four 1/4" flat washers (C).

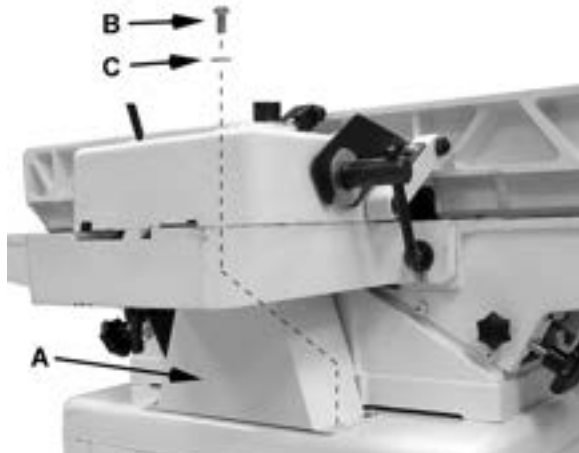

Figure 6-6

## 6.7 Installing Cutterhead Guard

1. Remove the screw from the guard post.

Refer to Figure 6-7:

2. Turn *spring knob* (B) approximately one and one-half revolutions counterclockwise (as viewed from the top) and hold.
3. Insert the *guard post* into hole in table. Make sure that the spring inside the spring knob (B) engages the slot in guard post.
4. Thread the *screw* (C) back into the *guard post*.
5. Check for proper operation. The *cutterhead guard* (A) must return fully to the fence when released. If guard does not return fully, pull guard, apply more tension to the *spring knob* (B) by turning it another half turn counterclockwise, and re-insert guard. If guard closes too quickly and strikes fence too hard, release some tension on the spring.
6. Insert *screw* (C) back into the guard post.

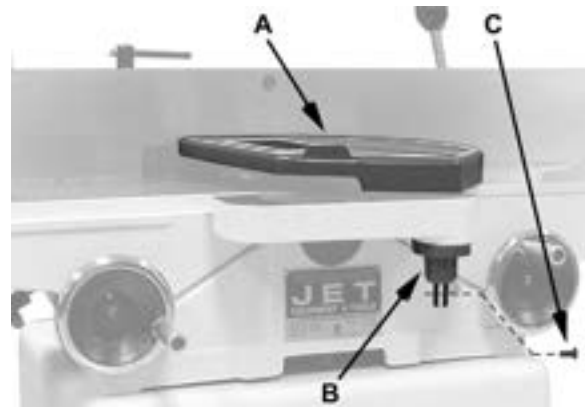

Figure 6-7

## 6.8 Installing Access Cover

Refer to Figure 6-8:

Install *access cover* (A) by placing bottom of panel in the stand and fastening with four #5-40 x 3/8" pan head screws and four flat washers (B).

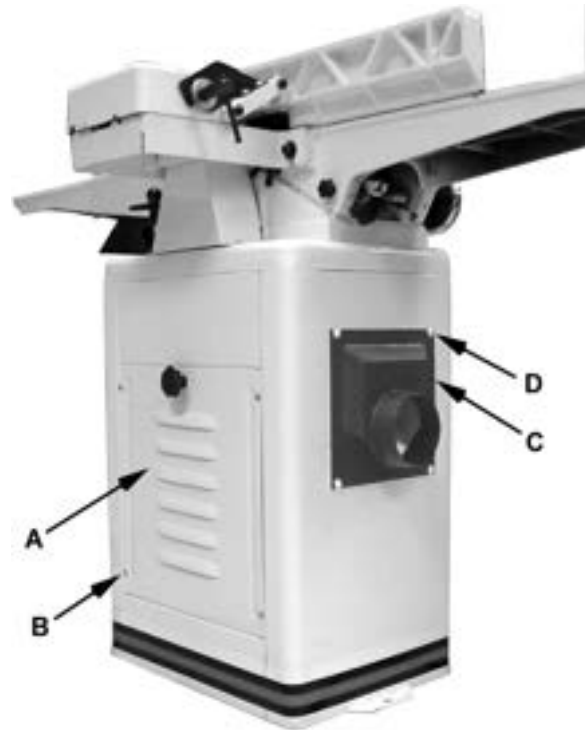

Figure 6-8

## 6.9 Installing Dust Chute

Refer to Figure 6-8:

Attach the dust chute (C) to the base with four 1/4" x 1/2" machine screws and four 1/4" washers (D).

## 7.0 Electrical Connections

### 7.1 GROUNDING INSTRUCTIONS

**CAUTION** This jointer must be grounded while in use to protect the operator from electric shock.

In the event of a malfunction or breakdown, grounding provides a path of least resistance for electric current to reduce the risk of electric shock. This tool is equipped with an electric cord having an equipment-grounding conductor and a grounding plug. The plug must be plugged into a matching outlet that is properly installed and grounded in accordance with all local codes and ordinances.

Do not modify the plug provided. If it will not fit the outlet, have the proper outlet installed by a qualified electrician. Improper connection of the equipment-grounding conductor can result in a risk of electric shock. The conductor, with insulation having an outer surface that is green with or without yellow stripes, is the equipment-grounding conductor. If repair or replacement of the electric cord or plug is necessary, do not connect the equipment-grounding conductor to a live terminal.

Check with a qualified electrician or service personnel if the grounding instructions are not completely understood, or if in doubt as to whether the tool is properly grounded. Use only three wire extension cords that have three-prong grounding plugs and three-pole receptacles that accept the tool's plug.

Repair or replace a damaged or worn cord immediately.

### 7.2 115-Volt Operation

Refer to Figure 7-1:

As received from the factory, your Woodworking Jointer is ready to run at 115-volt operation. This Jointer, when wired for 115 volt, is intended for use on a circuit that has an outlet and a plug that look like the ones illustrated in **A**, Figure 7-1. A temporary adapter, which looks like the adapter shown in **B**, may be used to connect this plug to a two-pole receptacle if a properly grounded outlet is not available.

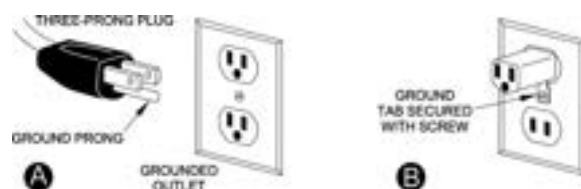

Figure 7-1

The temporary adapter should only be used until a properly grounded outlet can be installed by a qualified electrician. The green colored rigid ear, lug, or tab, extending from the adapter, must be connected to a permanent ground such as a properly grounded outlet box.

*In Canada, the use of a temporary adaptor is not permitted by the Canadian Electrical Code, C22.1.*

### 7.3 230-Volt Operation

Refer to Figure 7-2:

If 230V, single-phase operation is desired, the following instructions must be followed:

1. Disconnect the machine from the power source.
2. The Jointer motor has four numbered leads that are factory connected for 115V operation, as shown in **A**, Figure 7-2. For 230V operation reconnect the leads as shown in **B**.
3. The 115V attachment plug (**C**) supplied with the Woodworking Jointer must be replaced with a UL/CSA listed plug suitable for 230V operation (**D**). Contact your local Authorized JET Service Center or qualified electrician for proper procedures to install the plug. The Woodworking Jointer must comply with all local and national codes after the 230-volt plug is installed.
4. The Woodworking Jointer with a 230-volt plug should only be connected to an outlet having the same configuration as shown in (**D**). No adapter is available nor should be used with the 230-volt plug.

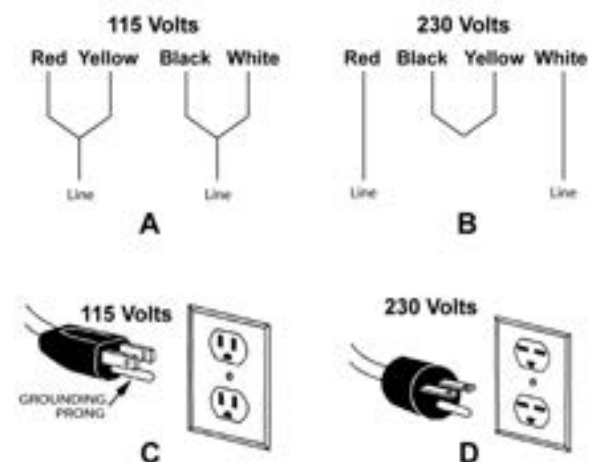

Figure 7-2

## 7.4 Extension Cords

Make sure your extension cord is in good condition. When using an extension cord, be sure to use one heavy enough to carry the current your machine will draw. An undersized cord will cause a drop in the line voltage resulting in power loss and overheating. Table 1 shows the correct size to use depending on the cord length and nameplate ampere rating. If in doubt, use the next heavier gauge. Remember, the smaller the gauge number, the heavier the cord.

### Recommended Extension Cord Gauges (AWG)

Amps	Extension Cord Length in Feet *					
	25	50	75	100	150	200
< 5	16	16	16	14	12	12
5 to 8	16	16	14	12	10	NR
8 to 12	14	14	12	10	NR	NR
12 to 15	12	12	10	10	NR	NR
15 to 20	10	10	10	NR	NR	NR
21 to 30	10	NR	NR	NR	NR	NR

\*based on limiting the line voltage drop to 5V at 150% of the rated amperes.

NR: Not Recommended.

Table 1

## 8.0 Adjustments

### 8.1 Drive Belt Tension

See step 4 of *Installing the Drive Belt*.

### 8.2 Fence Movement

The fence can be moved forward or backward across the width of the table (B, Fig. 8-1). It also tilts up to 45 degrees forward and has a positive stop at 90 degrees.

#### To Slide Fence Forward or Backward

When edge jointing, the fence assembly should periodically be moved to different positions to distribute wear on the cutterhead knives.

1. Loosen the *locking handle* (A, Fig. 8-1).
2. Push the entire fence assembly (B, Fig. 8-1) to the desired position, and tighten the locking handle.

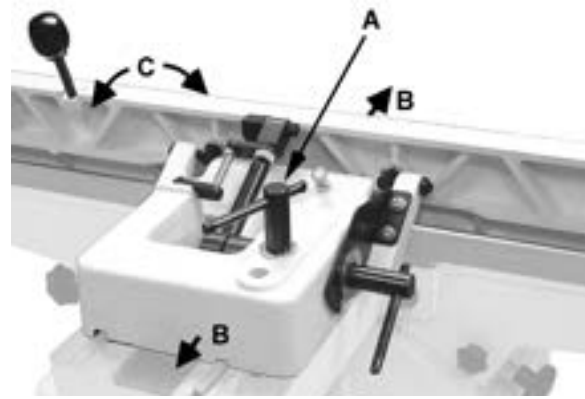

Figure 8-1

#### To Tilt Fence Forward

The fence can be tilted forward to any angle down to 45 degrees.

1. Loosen locking handle (C, Figure 8-2).
2. Move the lever forward (A, Figure 8-2) to the desired angle down to 45 degrees. Or you can place your reference piece on the table and against the fence and adjust the fence until the angle of the fence matches the bevel of your gauge piece.
3. Tighten locking handle (C, Figure 8-2).

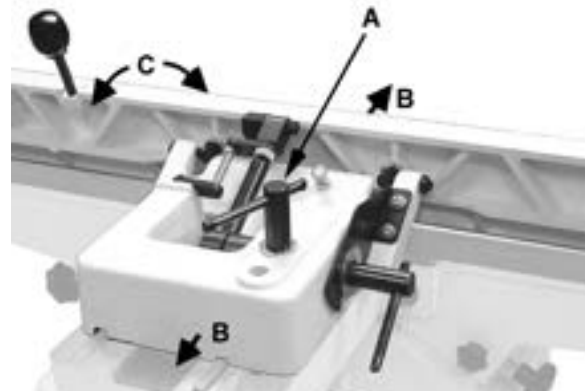

Figure 8-2

#### To Tilt Fence Backward

1. The fence can be tilted backward up to 45° (that is, for a total included angle of 135° from table surface).
2. Loosen locking handle (C, Fig. 8-2).
3. Flip the 90° stop block (D, Fig. 8-2) out of the way.

Move the lever (B, Fig. 8-2) back to the desired angle up to 135 degrees. Or you can place your beveled reference piece on the table and against the fence, adjusting the fence until the angle of the fence matches the bevel of your gauge piece.

5. Tighten locking handle (C, Fig 8-2).

4. **Important:** When the tilted operation is finished and the fence is returned to 90°, do not forget to flip the 90° stop block (D, Fig. 8-2) back to its original position.

### To Tilt Fence Backward

5. The fence can be tilted backward up to 45° (that is, for a total included angle of 135° from table surface).
6. Loosen locking handle (C, Fig. 8-2).
7. Flip the 90° stop block (D, Fig. 8-2) out of the way.
8. Move the lever (B, Fig. 8-2) back to the desired angle up to 135 degrees. Or you can place.

### 8.3 Fence Stop Adjustments

Periodically check the 90° and 45° backward (135°) tilt accuracy of the fence with an angle measuring device, such as an adjustable square or machinist's protractor.

#### 90° Fence Adjustment

Refer to Figure 8-3:

The 90° stop is controlled by the *stop bolt* (E) and the *stop plate* (C).

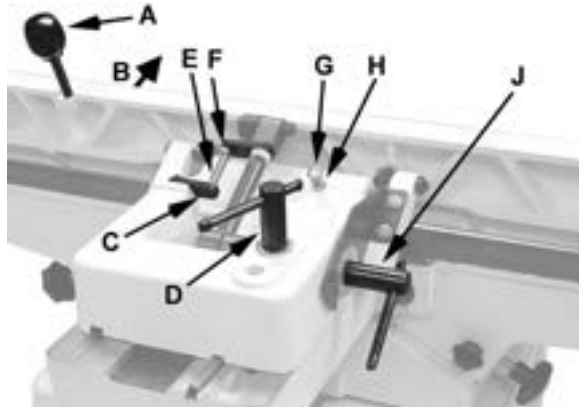

Figure 8-3

1. Set the infeed table to approximately the same height as the outfeed table.
2. Move the fence by releasing *lock handle* (D) and pushing the fence assembly until it overlaps the tables (B).
3. Tighten *lock handle* (D).
4. Adjust the fence to a 90° angle by releasing *lock handle* (J), pulling up on the *fence handle* (A), and tightening the *lock handle* (J).

**Note:** The *stop bolt* (E) should be resting against the *stop plate* (C).

5. Place an angle measuring device on the table and against the fence to confirm a 90° setting (A, Fig. 84).
6. If the fence is not square to the table, release the *lock handle* (J), loosen the hex nut (F), and turn the *stop bolt* (E) until the fence is square to the table.
7. Tighten the lock nut (F) to retain the setting. Tighten the lock handle (J).



Figure 8-4

#### 45° Fence Backward Stop Adjustment

Refer to Figure 8-5:

The 45° fence backward stop (fence positioned away from the operator) is controlled by the *stop bolt* (E).

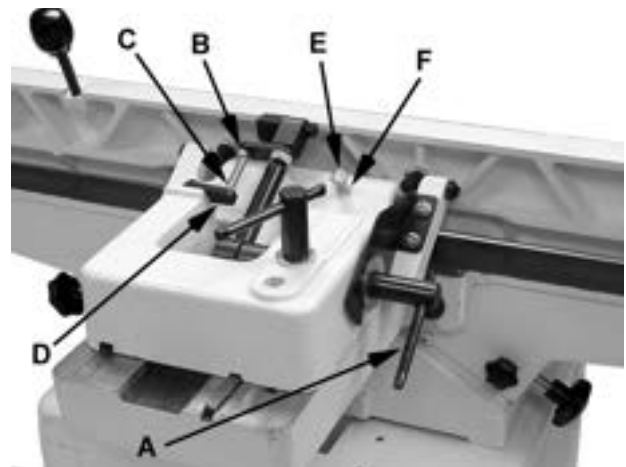

Figure 8-5

1. Loosen the lock handle (A). Move the stop plate (D) out of the way and position the fence at the 135° angle. Make sure the fence sits against the stop bolt. (E).
2. Tighten the lock handle (A).
3. Place an angle measuring device on the table and against the fence to confirm a 135° setting (A, Fig. 8-6).

- To adjust, loosen the lock nut (F), turn the stop bolt (E) until a 135° angle is obtained.
- Tighten the lock nut (F).



Figure 8-6

### 8.4 Infeed Table Depth Stop

Referring to Figure 8-7:

The *infeed table depth stop* (A) limits the depth of a cut (set by adjusting the infeed table handwheel) to a maximum depth of 1/8". For normal operations, a depth of cut of 1/8" or less is recommended, except for rabbeting operations.

If a rabbeting operation is desired:

- Lower the infeed table to 1/8", which will cause the depth stop limiter to engage.
- Loosen the lock handle (B) and pull out on the stop handle (C).
- Continue lowering the table to the desired depth of cut.

**Important:** Never override the depth stop limiter unless performing rabbeting operations.

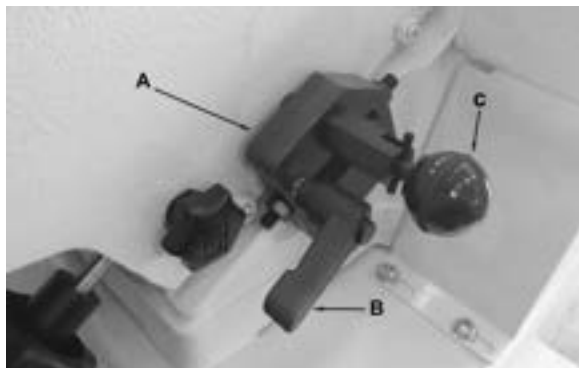

Figure 8-7

### 8.5 Gib Adjustment

After a period of use, the gibs may become loose and need adjusting.

To adjust (refer to Figure 8-8):

- Loosen setscrew locknuts (A) and wing screws (B).

**Note:** The infeed table has three gib adjustment screws A (Infeed). The outfeed table has two gib adjustment screws A (Outfeed) and two gib lock wing screws (B).

- Tighten each setscrew 1/4 turn starting at the bottom and working up. If a 1/4 turn does not remove all play, take another 1/4 turn. Repeat a 1/4 turn at a time for all three (or two) set screws until play is removed.
- Tighten wing screws (B) and lock nuts (A).

**Important:** If gibs are adjusted, also perform the *Outfeed Table Adjustment* to ensure the proper knife height in relation to the outfeed table.

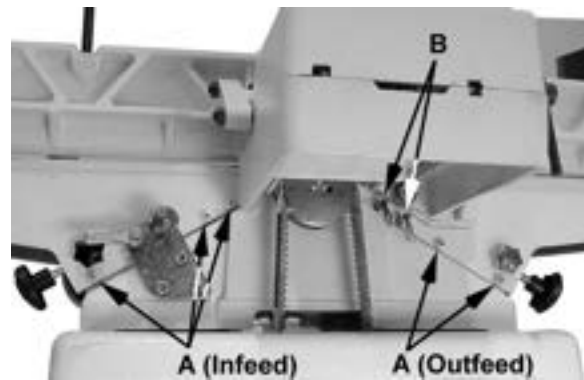

Figure 8-8

### 8.6 Outfeed Table Adjustment

When you receive the jointer, the knives have been pre-set at the factory. However, the height and parallelism of the knives with the outfeed table should be checked, and any needed adjustments made, before putting the jointer into operation.

Adjust the height of the outfeed table as follows:

- Disconnect jointer from power source.
- Carefully number each blade with a marker to make them easier to differentiate.
- Place a straightedge upon the outfeed table and extend it over the cutterhead (Figures 8-9 and 8-10).

**WARNING** Jointer knives are dangerously sharp. Do not grab the cutterhead itself to rotate it. Failure to comply may cause serious injury.

- Rotate the *cutterhead*, using the drive belt or pulley, until *knife number one* is at its highest point. The apex of the knife should just barely come in contact with the straightedge.

If the apex of the *knife number one* just makes contact with the straightedge, no adjustment is required for the outfeed table. Proceed to the *Setting Cutterhead Knives* section.

If the apex of the *knife number one* comes below the straightedge (a gap exists) or pushes the straightedge up, proceed with the following steps:

5. Loosen both *gib lock screws* (B, Fig. 8-8) and the *lock knob* (Figure 8-9).
6. Raise or lower the *outfeed table* until the *straight edge* contacts the *knife tip*, as shown in Figure 8-10. Using the drive belt or pulley, rock the cutterhead slightly to make sure the apex of the knife is just barely contacting the *straight edge*.

When adjustment is complete:

7. Lock the *outfeed table* at that setting by tightening the *lock knob* (Figure 8-9) and *gib lock screws* (B, Fig. 8-8). The outfeed table adjustment is complete.

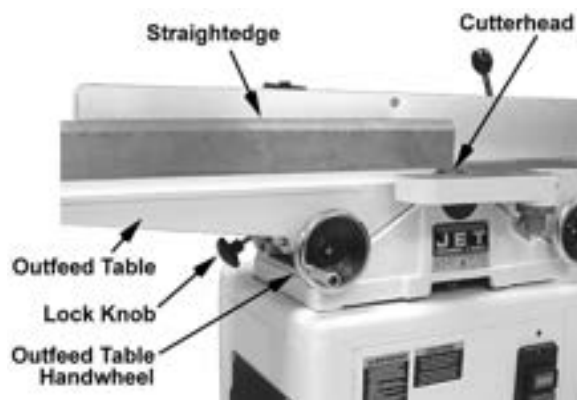

Figure 8-9

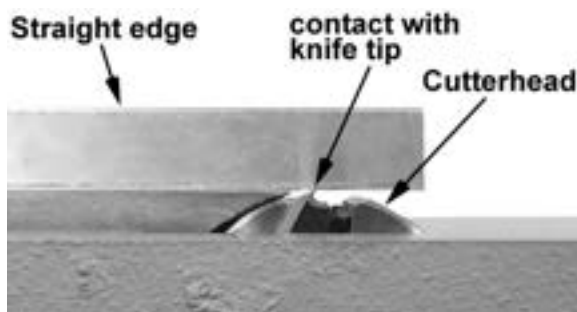

Figure 8-10

The outfeed table adjustment is only made against one knife (blade number one was arbitrarily selected here). After the outfeed table has been set at the correct height, do not change it except for special operations or after replacing knives.

After this adjustment is completed, it is necessary to proceed to the *Setting Cutterhead Knives* section to verify that all three knives are at the correct height and parallel to the outfeed table.

## 8.7 Setting Cutterhead Knives (JJ-6CSDX)

**Note:** Before setting knives for model JJ-6CSDX Joints, the *Outfeed Table Adjustment* should be done to ensure the proper knife height in relation to the outfeed table.

Knives for the JJ-6CSDX cutterhead are adjusted by means of a cam. It is important to note that the entire adjustment is accomplished within one complete rotation (360 degrees) of the cam. A full rotation of the cam will cause the knife blade to move a total of .015" from one extreme to the other. Turning the cam more than one full rotation will not further adjust the knife setting but will simply begin the adjustment all over again. The knife adjustment procedure is outlined below.

**WARNING** Cutterhead knives are dangerously sharp. Use extreme caution when inspecting, removing, sharpening, or replacing knives into the cutterhead. Failure to comply may cause serious injury.

To adjust (refer to Figures 8-11 & 8-12):

1. Disconnect jointer from power source.
2. Carefully number each blade with a marker to make them easier to differentiate.
3. Place a straightedge across the outfeed table extending it over the cutterhead towards one end of the knife.

**WARNING** Cutterhead knives are dangerously sharp. Do not grab the cutterhead itself to rotate it! Failure to comply may cause serious injury.

4. Rotate the cutterhead *back and forth* using the drive belt or pulley, until *knife number one* is at its highest point. The apex of the knife should just barely come in contact with the straightedge.
5. Move the straightedge *towards the other end of the knife* and repeat step 4.

The apex of the knife *at both ends of the knife* must *just make contact* with the straightedge. If the apex of the knife comes below the straightedge (a gap exists) or pushes the straightedge up, proceed to the next step.

6. Using a 4mm hex wrench, slightly loosen the four gib screws.
7. Using a 3mm hex wrench, loosen the cam locking screws to permit adjustment of the cam (described in the next step).

**Important:** Always keep the cam locking screws snug enough so that the cam can't rotate freely. This is especially important for when the cam is rotated counterclockwise since this action will cause the cam locking screw to loosen further.

8. Using an 8mm hex wrench, adjust the cam. This is a very sensitive adjustment. Start by rotating the cam in a clockwise direction just a few degrees.
9. Next, keep the cutterhead steady by firmly holding on to the pulley, place a piece of wood pressed against the knife's edge and press to properly seat the blade.
10. Check your progress by repeating steps 4 and 5. If the knife becomes more out of adjustment, turn the cam in the other direction.
11. The adjustment is almost complete when the requirements described in Steps 4 and 5 are met.
12. Next, while pressing the knife firmly against the cam, snug the two inside gib screws that hold the gib and knife in place. Verify that the knife is still in adjustment (steps 4 and 5).
13. Tighten the two outside gib screws, then the two inside gib screws. Verify that the knife is still in adjustment (steps 4 and 5).
14. Tighten the gib lock screws.
15. Repeat this entire procedure for the remaining two knives.

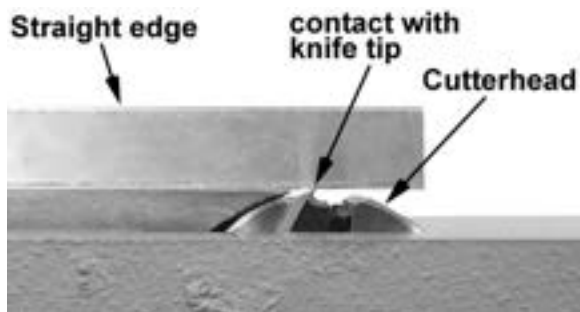

Figure 8-11

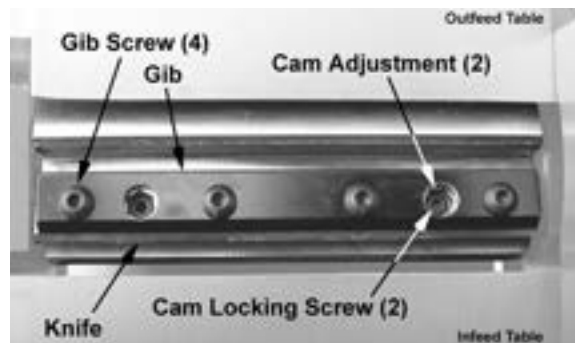

Figure 8-12

## 8.8 Replacing Knives (JJ-6CSDX)

**WARNING** Jointer knives are dangerously sharp. Use extreme caution when inspecting, removing, or replacing knives.

To remove/replace a knife (Refer to Figure 8-13):

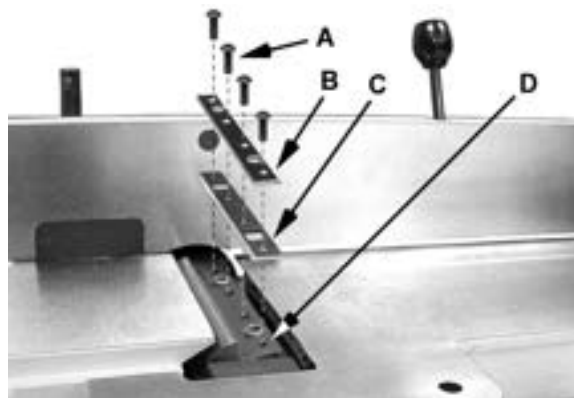

Figure 8-13

1. Remove four *gib screws* (A) with a 4mm hex wrench.
2. Remove the *gib* (B) and *knife* (C).  
If the knife is being reused (knives are double-edged), clean the knife, gib and cutterhead of all pitch and debris.
3. Lay the new knife or unused edge of the old knife back onto the *cutterhead* (D).
4. Replace the *gib* (B) and *screws* (A). Finger tighten only at this time.
5. Press against the cutting edge of the knife at the center of the blade with a piece of wood. **DO NOT USE FINGERS!** This is to ensure that the cam is making proper contact with the knife.
6. Snug the inside two screws, then the outside two screws.



7. Release the piece of wood pressing against the knife and tighten the gib screws.
8. Replace the remaining two blades by repeating steps 1 – 7.
9. Determine if knives need to be set.

Follow the *Outfeed Table Adjustment* section steps 3 and 4 only to determine if knives need to be set. **Do not complete the entire outfeed table adjustment.** If knives need to be set, proceed to the *Setting Cutterhead Knives* section.

## 8.9 Setting Knives for Rabbeting and Nicks

(NOTE: Rabbeting is not applicable to the JJ-6HHDX helical head jointer)

To position the knives for rabbet cuts, take a shop scale with 1/32" graduations and place it against the end of the cutterhead. Slide the knife out until it is at the 1/32" mark on the scale; that is, the knife will now be 1/32" beyond the edge of the cutterhead. The gib should remain in normal position, even with the edge of the cutterhead. (Figure 30). This adjustment will ensure that the knife clears the end of the gib and cutterhead and has good contact with the workpiece. (See the *Rabbeting* section for further information.)

**Note:** This will also correct for small nicks without requiring replacement of knives.

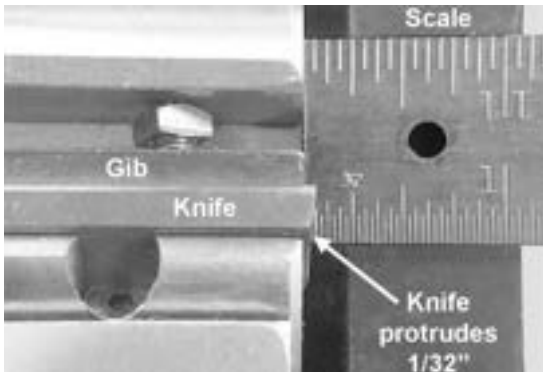

Figure 8-14

## 8.10 Rotating and Replacing Knife Inserts (JJ-6HHDX)

**WARNING** Knife inserts are dangerously sharp. Use extreme caution when inspecting, removing, or replacing knife inserts.

The knife inserts on the model JJ-6HHDX Jointer are four-sided. When dull, simply remove each insert, rotate it 90° for a fresh edge, and re-install it. No further adjustment is necessary.

Use the two provided star point screwdrivers to remove the knife insert screw. Use one of the screwdrivers to help hold the cutterhead in position, and the other to remove the screw. See Figure 8-15. It is advisable to rotate all inserts at the same time to maintain consistent cutting. However, if one or more knife inserts develops a nick, rotate only those inserts that are affected.

Each knife insert has an etched reference mark so you can keep track of the rotations.

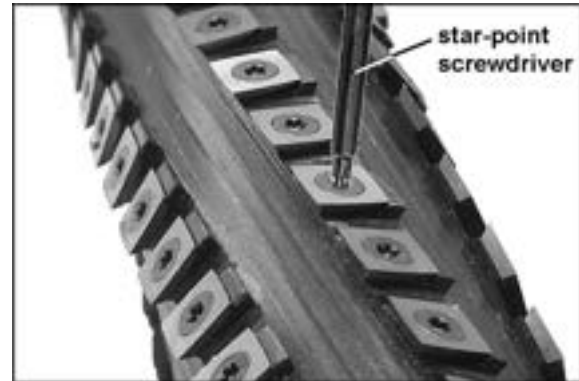

Figure 8-15 – HH models only

**IMPORTANT:** When removing or rotating inserts, clean saw dust from the screw, the insert, and the cutterhead platform. Dust accumulation between these elements can prevent the insert from seating properly and may affect the quality of the cut.

Before installing each screw, lightly coat the screw threads with machine oil and wipe off any excess.

Securely tighten each screw which holds the knife inserts before operating the planer!

**WARNING** Make sure all knife insert screws are tightened securely. Loose inserts can be propelled at high speed from a rotating cutterhead, causing injury.

## 8.11 Determining Correct Table Height

When you receive the jointer, the knives have been pre-set at the factory. However, the height and parallelism of the knives with the outfeed table should be checked, and any needed adjustments made, before putting the jointer into operation.

The *outfeed table* and *cutterhead knives* are correctly adjusted when all three blades are parallel to the outfeed table and all three blades are set at the same height in the cutterhead.

*Outfeed table too high* – If the outfeed table is too high, a curved finished surface results (Figure 8-16).

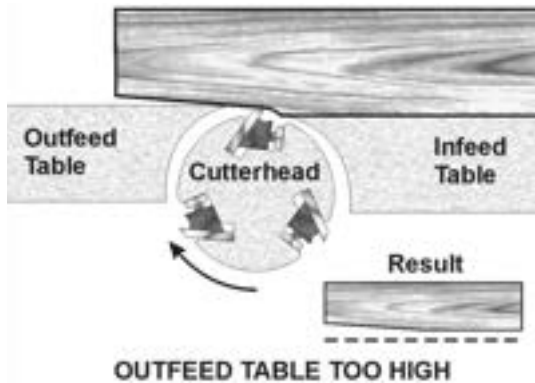

Figure 8-16

*Outfeed table too low* – If the outfeed table is too low, the work will have a gouge, or snipe, at the end of the cut (Figure 8-17).

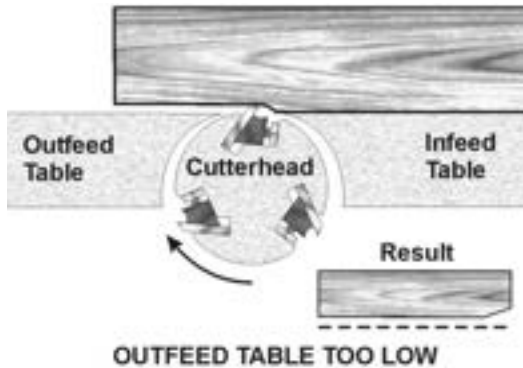

Figure 8-17

*Outfeed table at correct setting* – Figure 8-18 illustrates the correct setting of outfeed table level with the knives. The workpiece will rest firmly on both tables with no open space under the finished cut.

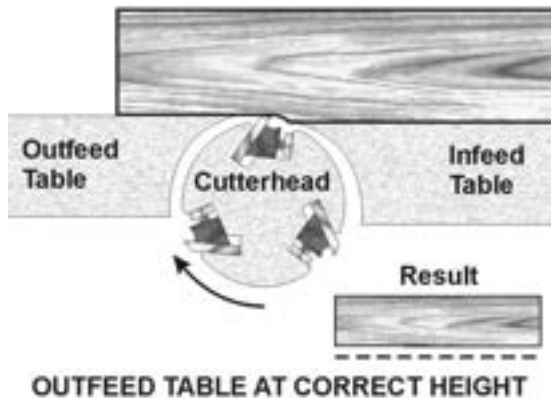
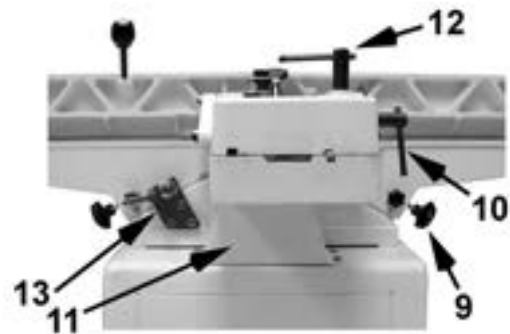

Figure 8-18

## 9.0 Operating Controls



Front



Back

1. Handwheel for Outfeed Table
2. Outfeed Table
3. Fence
4. Fence Adjustment Handle
5. Cutter Guard
6. Infeed Table
7. Handwheel for Infeed Table
8. On/Off Switch
9. Table Lock Knob
10. Fence Tilt Lock Handle
11. Belt Guard
12. Fence Travel Lock Handle
13. Depth Limiter

## 10.0 Operation

**Important:** Before operating the jointer, make sure all knives or knife inserts are seated and secure in the cutterhead.

If you are inexperienced at jointing, use scrap pieces of lumber to check settings and get the feel of operations before attempting regular work.

Stabilize long workpieces by using an assistant, or roller stands set level with the outfeed or infeed table surface.

The fence should be adjusted to create minimum exposure to the cutterhead during the jointing operation.

Check the following before operating the jointer:

- ❑ Outfeed table must be set level with the high point of the knives or knife inserts.
- ❑ Fence adjusted for minimum exposure of cutterhead and locked at desired angle.
- ❑ The cutterhead guard must be in place and operating properly (except when rabbeting).
- ❑ Infeed table set for desired depth of cut.
- ❑ Stand away from the cutterhead and turn the machine on for a few moments. Listen for any odd noises, rubbings, vibrations, etc. Correct such problems before attempting operations on the jointer.
- ❑ Carefully check your workpiece for knots, holes, staples, or any foreign material that might damage knives or pose a risk of kickback. Also check the workpiece for grain orientation.

### 10.1 Hand Placement

**WARNING** Never pass hands directly over the cutterhead.

At the start of the cut, the left hand holds the workpiece firmly against the infeed table and fence while the right hand pushes the workpiece in a smooth, even motion toward the cutterhead (Figure 10-1). After the cut is under way, the new surface rests firmly on the outfeed table. The left hand is transferred to the outfeed side and presses down on this part of the workpiece, at the same time maintaining flat contact with the fence. The right hand presses the workpiece forward and before the right hand reaches the cutterhead it should be moved to the work on the outfeed table.



Figure 10-1

### 10.2 Surfacing

**WARNING** Always use a hold down or push block when surfacing stock.

Surfacing, or jointing the face of stock, is shown in Figure 10-2. Adjust the infeed table for depth of cut. Cuts of approximately 1/8" or less at a time are recommended, which provides better control over the material being surfaced. More passes can then be made to reach the desired depth.



Figure 10-2

### 10.3 Edge Jointing

Edge Jointing (Figure 10-3) is the most common operation for the jointer. Set fence square with the table. Depth of cut should be the minimum required to obtain a straight edge. Do not make cuts deeper than 1/8" in a single pass. Hold the best face of the workpiece firmly against the fence throughout the feed.



Figure 10-3

## 10.4 Rabbeting

A rabbet is a groove cut along the edge of a board. See Figure 10-4. The width and thickness of the wood to be rabbeted depends upon the width and length of the rabbet. However, never rabbet a piece of wood less than 12" long.



Figure 10-4

**Note:** The knives must be extended beyond the cutterhead by 1/32". See the *Setting Knives for Rabbeting and Nicks* section on page 18 for this procedure.

**WARNING** Rabbeting requires the removal of the cutterhead guard. Use extreme caution and keep hands clear of the cutterhead. Replace the guard immediately after rabbeting is completed! Failure to comply may cause serious injury!

*Note: Rabbet cuts are not applicable with the Model JJ-6HHDX Jointer with helical head.*

Use push blocks to rabbet cut whenever possible. The rabbeting capacity is 1/2".

1. Disconnect jointer from power source.
2. Set fence for desired width of rabbet.

3. Check width of the rabbet by measuring the distance from the end of a knife in the cutterhead to the fence.
4. Re-connect power. It is easier and safer to take a series of shallow cuts. Lower the infeed table 1/32" at a time and make successive cuts until the desired depth of rabbet has been obtained. See Figure 10-4.

## 10.5 Jointing Short or Thin Work

When jointing short or thin work pieces, use a push block to eliminate all danger to the hands. Two push blocks are shipped with your jointer. You can also make your own easily from scrap material. Examples are shown in Figure 10-5.

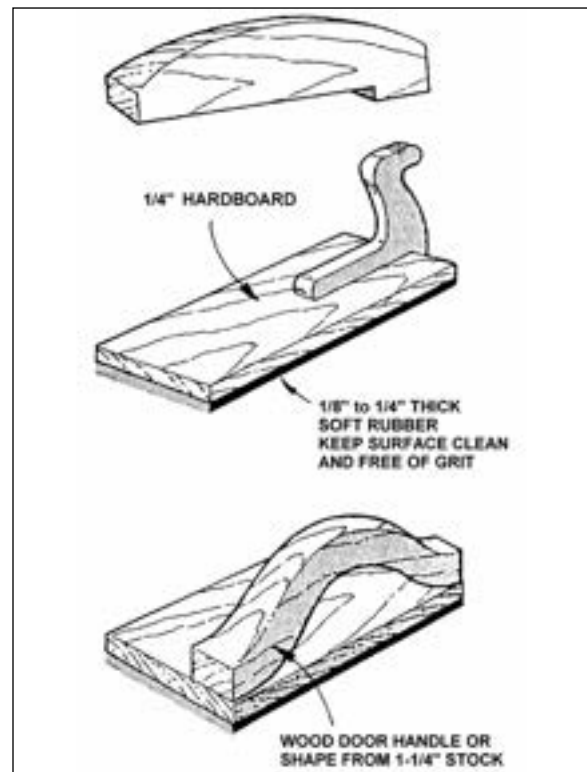

Figure 10-5

## 10.6 Jointing Warped Surfaces

If the wood to be jointed is cupped or bowed, place the concave side down, and take light cuts until the surface is flat.

Avoid forcing such material down against the table – excessive pressure will spring it while passing the knives, and it will spring back and remain curved after the cut is completed.

## 10.7 Beveling

To cut a bevel, lock the fence at the required angle and run the work piece across the knives while keeping it firmly against the fence and tables. Do not make cuts deeper than 1/8" in a single pass. Several passes may be necessary to achieve the desired result.

**CAUTION** Although the fence may be tilted in or out for a bevel cut, it is recommended for safety reasons that the fence be tilted in toward the operator, making a cradled cut.

## 10.8 Direction of Grain

Avoid feeding work into the jointer against the grain. This may result in chipped and splintered edges. See Figure 10-6. Feed *with* the grain to obtain a smooth surface, as shown in Figure 10-7.

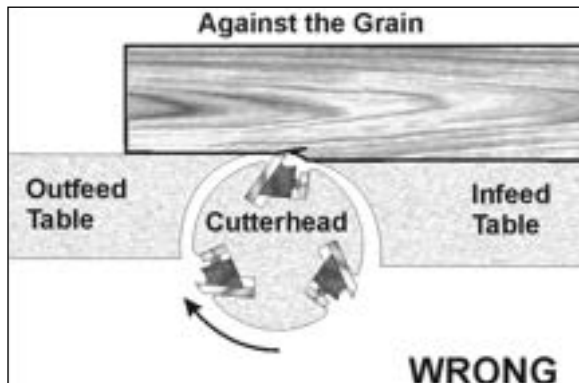

Figure 10-6

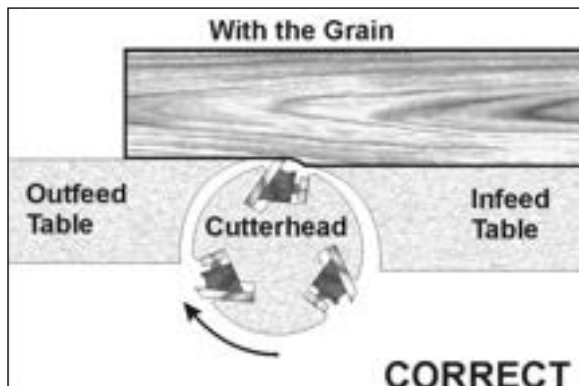

Figure 10-7

## 11.0 Maintenance

### 11.1 Blade Care

**WARNING** Blades are extremely sharp. Use caution when cleaning or changing. Failure to comply may cause serious injury.

When gum and pitch collect on the blades, carefully remove with a strong solvent. Failure to remove gum and pitch build-up may result in excessive friction, blade wear and overheating.

When blades become dull, replace them.

### 11.2 Cutterhead Removal

The entire cutterhead assembly may be removed for cleaning or for bearing and blade replacement. Some woodworkers keep a spare cutterhead with replacement blades should the original cutterhead have to be repaired.

**WARNING** Blades in the cutterhead are sharp. Use extreme caution when handling the removal of the cutterhead. Failure to comply may cause serious injury.

To remove the cutterhead (including bearings, studs, and housing) from the base casting:

Refer to Figure 10-8:

1. Disconnect the machine from the power source.
2. Remove the front *blade guard* (A) and *screw* (H).
3. Remove the *lock handle* (B), *washer* (C) and *lock nut* (D) securing the *fence assembly* (E) to the *table* (F).
4. Lift the *fence assembly* (E) from the table.
5. From the left side of the stand, remove the *dust chute* (G). From the back of the machine remove the *cabinet access cover* (not shown).

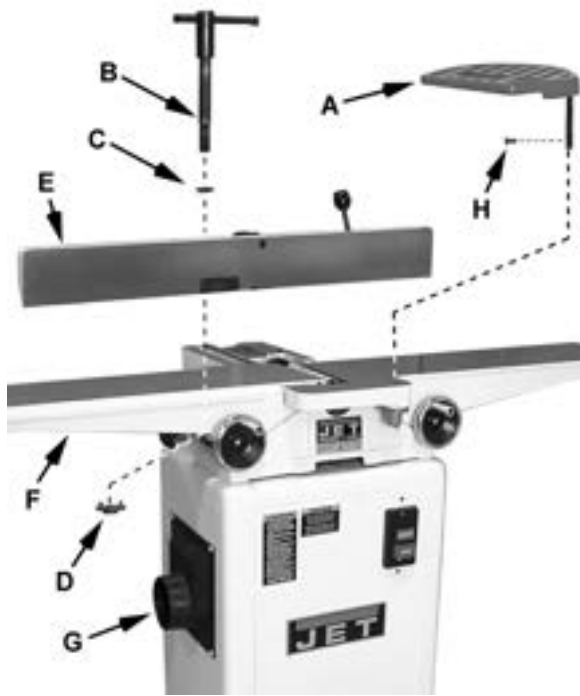

Figure 10-8

Refer to Figure 10-9:

6. Using an 8mm hex wrench, loosen two hex cap screws underneath *fence base casting* (E) that secure the casting to the *table* (F). Remove the *fence base casting* and set aside.
7. Remove four *screws and washers* (A) securing the *belt guard* (B). Remove the *belt guard*.
8. Remove the *V-belt* (C) from the *cutterhead pulley* (D). If necessary, loosen the *motor mounting screws* with a 12mm wrench to provide slack on the V-belt.
9. Using a 3mm hex wrench, loosen two set screws that secure the *cutterhead pulley* (D) to the *cutterhead shaft*. Set the pulley and shaft key aside.
10. Using a 14mm wrench, remove two *screws* (A, Fig. 10-10) and *lock washers* that secure the *cutterhead bearing housings* to the base.

**Note:** These screws and lock washers are more easily accessible through the dust chute.

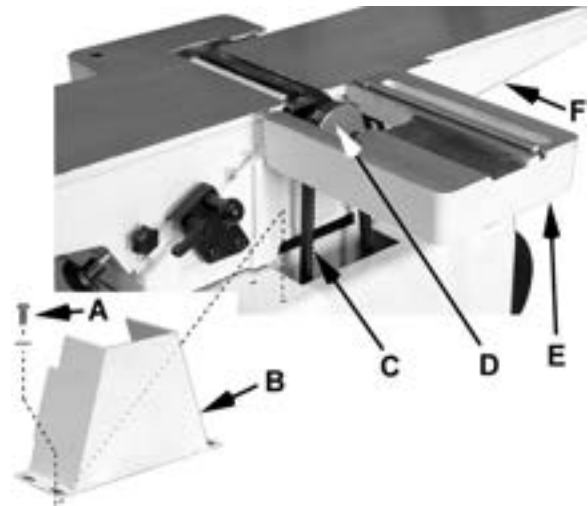

Figure 10-9



Figure 10-10

11. Carefully remove the *cutterhead* (A, Fig. 10-11).

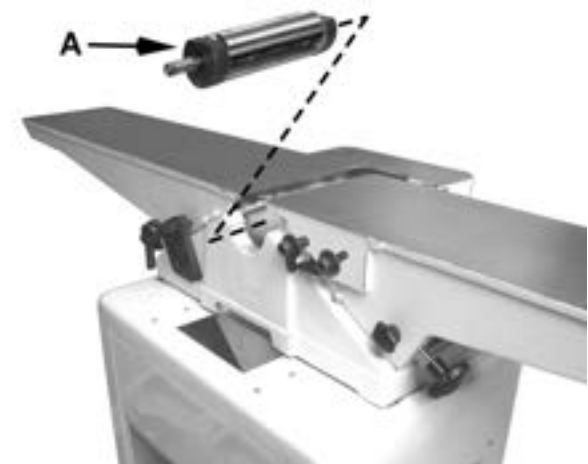

Figure 10-11

12. Before placing the new *cutterhead* back into the casting, thoroughly clean the "saddle" and the bearing housings of saw dust and grease so that they seat properly.

13. To re-install the cutterhead, reverse the above steps.

**Note:** Make sure that the fence base casting is level with the Outfeed table when securing.

### 11.3 Table Coplanarity

For optimum jointer performance, infeed and outfeed tables must be coplanar; that is, parallel front-to-back and side-to-side. If they are not parallel in both planes, the finished workpiece may have a slight taper across its width or length.

The tables have been properly aligned at the factory. However, this should be confirmed by the operator in case misalignment has occurred during shipping. Also, as the machine receives use, this coplanarity should be checked periodically and adjusted if necessary.

The following procedure uses a steel straight edge to set the tables, which should be accurate enough for most purposes. Adjustment of outfeed table is shown; procedure for infeed table will be identical.

1. **Disconnect jointer from power source.**
2. Remove cutterhead guard.
3. Slide fence assembly back until it clears the tables.
4. Loosen wing screws (B, Figure 8-8).
5. Loosen lock knob (Figure 8-9), and raise outfeed table *higher* than the cutterhead. Tighten lock knob.
6. Place straight edge across front of outfeed table and extending over infeed table.
7. Raise infeed table until it contacts straight edge, and tighten infeed table in position.

8. The straight edge should lie evenly across both tables without gaps between straight edge and table. Move straight edge to rear of outfeed table, and perform the same test.
9. If straight edge does not lie evenly, the front or back of table must be adjusted to make the tables coplanar. Proceed as follows:
10. Loosen locknuts and set screws (A, Figure 8-8) on outfeed table.
11. Place a thin metal shim, such as a piece of aluminum can, between outfeed table and dovetail slide, in the location that needs to be raised. Confirm the setting with the straight edge; use additional shim(s) if needed.
12. Tighten set screws (A, Figure 8-8) for appropriate dovetail movement, according to instructions under *Gib Adjustment*.
13. Tighten locknuts (A, Figure 8-8) and wing screws (B, Figure 8-8).
14. Recheck table and knife settings. See *sect. 8.6, 8.7, 8.11*.

## 12.0 Lubrication

- Use a good grade of light grease on the steel adjusting screws located in the raising and lowering mechanisms of the work tables.
- Occasionally, apply a few drops of light machine oil to the infeed/outfeed gibs. This permits the tables to slide freely.

The cutterhead ball bearings are lifetime lubricated and need no further care.

## 13.0 Troubleshooting

### 13.1 Operating Problems

Trouble	Probable Cause	Remedy
Finished stock is concave on back end.	Knife is higher than outfeed table.	Raise outfeed table until it aligns with tip of knife. See <i>sect. 8.6 Outfeed Table Adjustment</i> .
Finished stock is concave on front end.	Outfeed table is higher than knife.	Lower outfeed table until it aligns with tip of knife. See <i>sect. 8.6 Outfeed Table Adjustment</i> .
Chip out.	Cutting against the grain.	Cut with the grain whenever possible.
	Dull knives or knife inserts.	Sharpen or replace knives. Rotate or replace knife inserts.
	Feeding workpiece too fast.	Use slower rate of feed.
	Cutting too deeply.	Make shallower cuts.
	Knots, imperfections in wood.	Inspect wood closely for imperfections; use different stock if necessary.
Fuzzy grain.	Wood has high moisture content.	Allow wood to dry or use different stock.
	Dull knives or knife inserts.	Sharpen or replace knives. Rotate or replace knife inserts.
Cutterhead slows while operating.	Feeding workpiece too quickly, or applying too much pressure to workpiece.	Feed more slowly, or apply less pressure to workpiece.
"Chatter" marks on workpiece.	Knives incorrectly set.	Set knives properly as described in <i>sect. 8.7 Setting Cutterhead Knives</i> . Check that knife slots are clean and free of dust or debris.
	Feeding workpiece too fast.	Feed workpiece slowly and consistently.
Uneven knife marks on workpiece.	Knives are nicked, or out of alignment.	Align knives per <i>sect. 8.7, Setting Cutterhead Knives</i> . Replace nicked knives or correct for small nicks – see <i>sect. 8.9, Setting Knives for Rabbeting and Nicks</i> .

Table 2



## 13.2 Mechanical and Electrical Problems

Trouble	Probable Cause	Remedy
Machine will not start/restart or repeatedly trips circuit breaker or blows fuses.	No incoming power.	Verify unit is connected to power, on-button is pushed in completely, and stop-button is disengaged.
	Building circuit breaker trips or fuse blows.	Verify that jointer is on a circuit of correct size. If circuit size is correct, there is probably a loose electrical lead. Check amp setting on motor starter.
	Switch or motor failure (how to distinguish).	If you have access to a voltmeter, you can separate a switch failure from a motor failure by first, verifying incoming voltage at 110/220+/-10% and second, checking the voltage between switch and motor at 110/220+/-10%. If incoming voltage is incorrect, you have a power supply problem. If voltage between switch and motor is incorrect, you have a switch problem. If voltage between switch and motor is correct, you have a motor problem.
	Motor overheated.	Clean motor of dust or debris to allow proper air circulation. Allow motor to cool down before restarting.
	Motor failure.	If electric motor is suspect, you have two options: Have a qualified electrician test the motor for function or remove the motor and take it to a qualified electric motor repair shop and have it tested.
	Unit incorrectly wired.	Double check to confirm all electrical connections are correct. Refer to <i>sect. 16.0 Wiring Diagrams</i> to make any needed corrections.
	On/off switch failure.	If the on/off switch is suspect, you have two options: Have a qualified electrician test the switch for function, or purchase a new on/off switch and establish if that was the problem on change out.

Table 3

## 14.0 Optional Accessories

708801DX..... Knives for Model JJ-6CSDX Jointer (set of 3)  
708815..... Push Block  
1791212..... Knife Inserts for Model JJ-6HHDX (set of 10)

## 15.0 Replacement Parts

To order parts or reach our service department, call 1-800-274-6848 Monday through Friday, 8:00 a.m. to 5:00 p.m. CST. Having the Model Number and Serial Number of your machine available when you call will allow us to serve you quickly and accurately.

Non-proprietary parts, such as fasteners, can be found at local hardware stores, or may be ordered from JET.

Some parts are shown for reference only, and may not be available individually.

15.1.1 Fence Assembly (All Models) – Exploded View

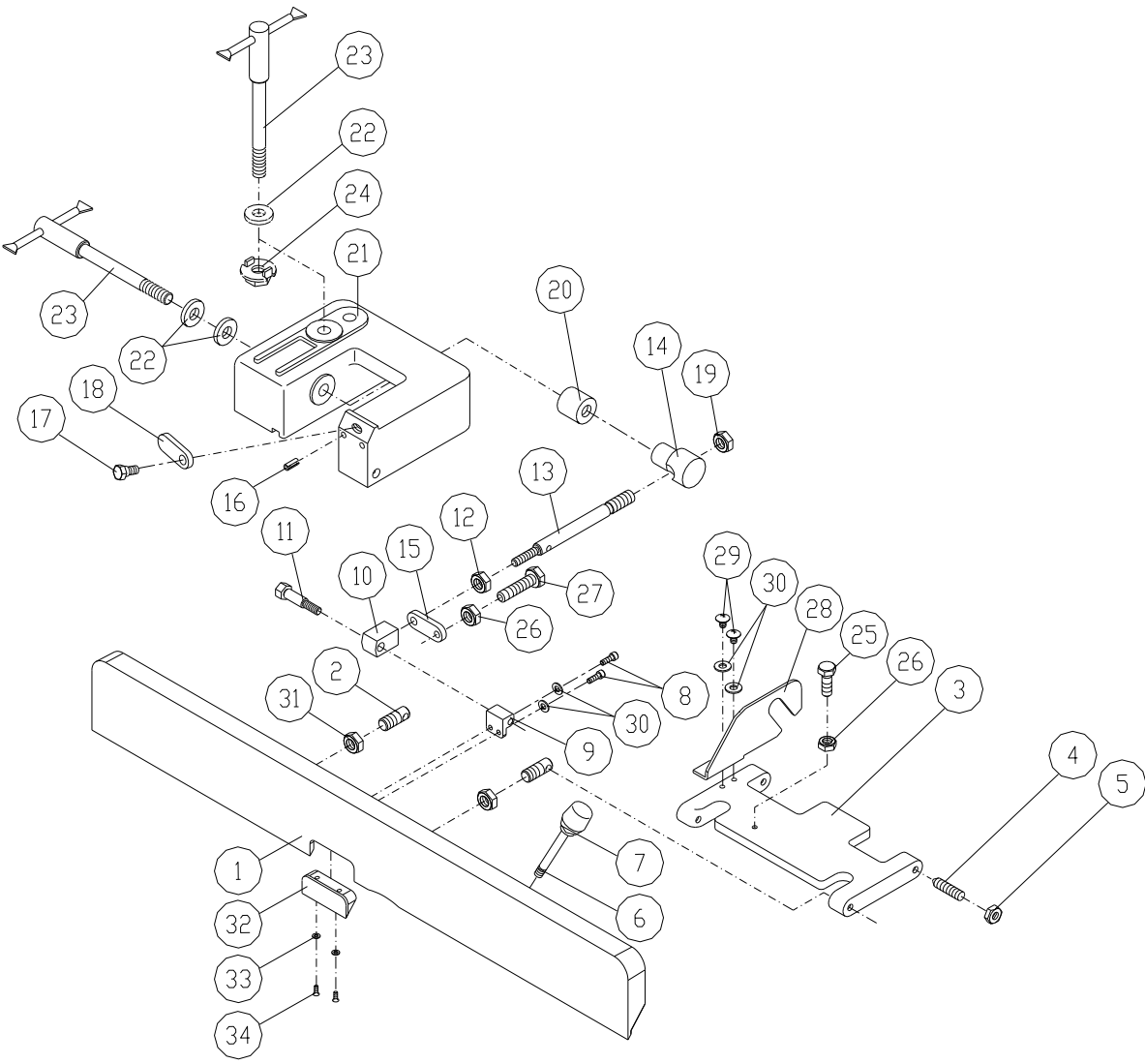

## 15.1.2 Fence Assembly (All Models) – Parts List

Index No.	Part No.	Description	Size	Qty.
	JJ6CSDX-FAC	Fence Assembly Complete		1
1	JJ6CSDX-201	Fence Body		1
2	JEJ-F14	Fence Link		2
3	JJ6CSDX-203	Tilt Plate		1
4	JED-F16	Threaded Stud		4
5	TS-0561031	Hex Nut	3/8"-16	4
6	JEB-F09	Handle		1
7	5DF-109	Knob		1
8	TS-0207041	Socket Head Cap Screw	1/4"-20x3/4"	2
9	PJ882-142	Fixed Block		1
10	JEJ-F03	Block		1
11	JEJ-F04	Bolt		1
12	TS-0561041	Hex Nut	7/16"-14	1
13	JEJ-F05	Stud		1
14	JEJ-F06	Swivel Block		1
15	JEJ-F07	Plate		1
16	5FF-J12	Spring Pin	Ø4x12 mm	1
17	JEJ-F08	Hex Cap Bolt		1
18	JEJ-F09	Plate		1
19	TS-0640132	Hex Nylon Lock Nut	5/8"-18UNF	1
20	JEJ-F10	Bushing		1
21	JJ6CSDX-221	Fence Bracket		1
22	TS-0680061	Flat Washer	1/2"	3
23	JEJ-F12	Lock Handle		2
24	JED-F17	Lock Nut		1
25	TS-0051051	Hex Cap Screw	5/16"-18x1"	1
26	TS-0561021	Hex Nut	5/16"-18	2
27	TS-0051081	Hex Cap Screw	5/16"-18x1-3/4"	1
28	JED-F03	Plate		1
29	TS-0813032	Screw	1/4"-20x1/2"	2
30	TS-0680021	Flat Washer	1/4"	4
31	TS-0561052	Hex Nut	1/2"-20UNF	2
32	PJ882-144	Pad Block		1
33	TS-069204	Flat Washer	#10	2
34	TS-0206021	Socket Head Cap Screw	#10-24x1/2"	2

15.2.1 Stand Assembly, JJ-6CSDX – Exploded View

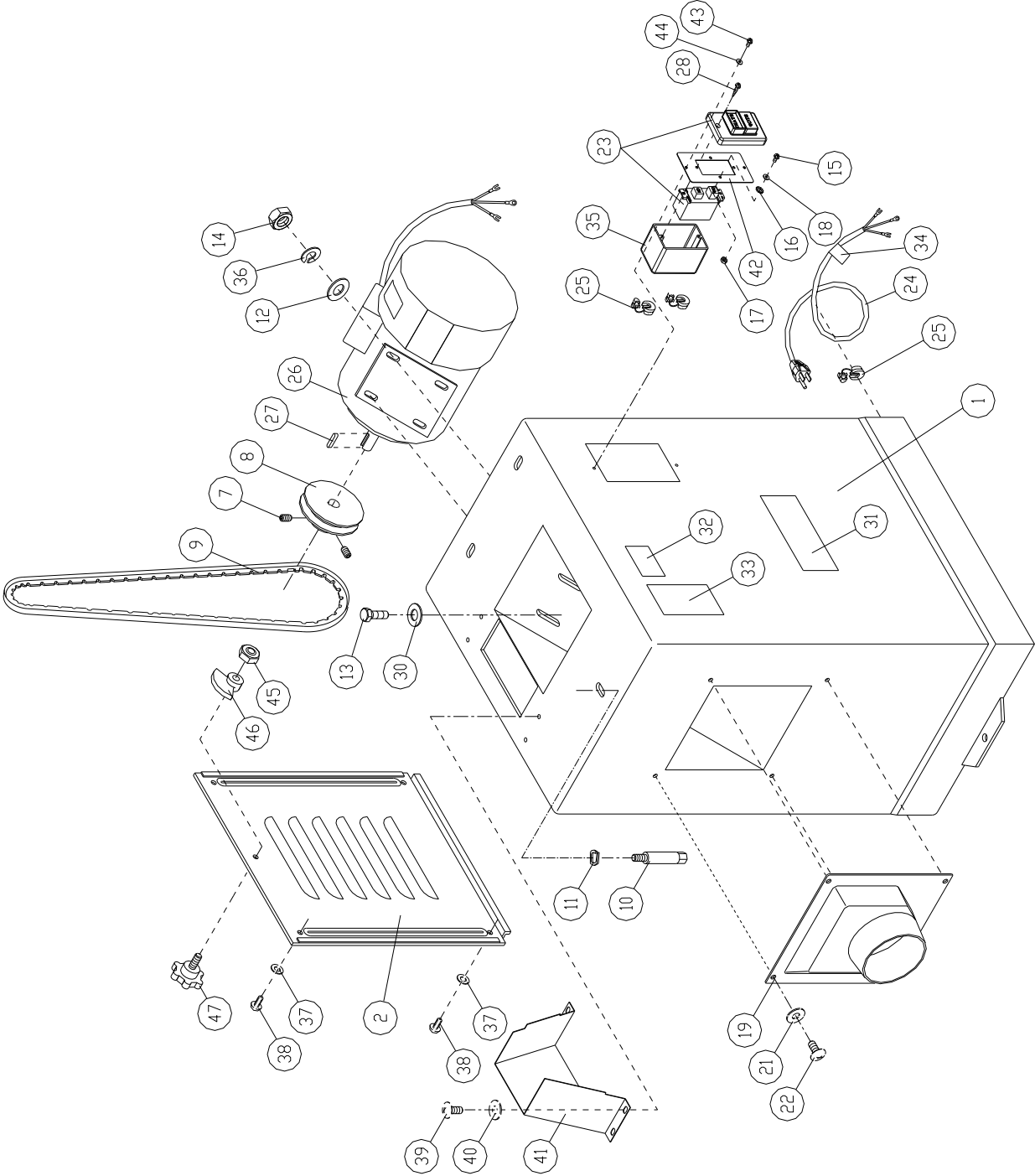

## 15.2.2 Stand Assembly, JJ-6CSDX – Parts List

Index No.	Part No.	Description	Size	Qty.
1	JI-Y01W	Stand Body		1
2	JI-Y01AW	Access Cover		1
7	TS-0267041	Set Screw	1/4"-20x3/8"	2
8	6296125	Motor Pulley		1
9	VB-A37	V-Belt	A-37	1
10	JC-M07	Lock Bolt*	3/8"-16	3
11	TS-0720091	Lock Washer*	3/8"	3
12	TS-0680031	Flat Washer	5/16"	4
13	TS-0051031	Hex Head Bolt	5/16"-18x3/4"	4
14	TS-0561021	Hex Nut	5/16"-18	4
15	TS-081B042	Screw	#8-32x5/8"	2
16	5EA-D05	Star Washer	#8	2
17	TS-0560061	Hex Nut	#8-32	2
18	TS-1550021	Flat Washer	M4	2
19	JEX-S02	Dust Chute		1
21	TS-0680021	Flat Washer*	1/4"	4
22	TS-081F032	Screw*	1/4"-20x1/2"	4
23	994542	Switch		1
24	JI-X02	Power Cord		1
25	5QA-I04	Strain Relief Bushing		3
26	JI-X04W	Motor	1HP	1
	JI-X04-AA	Centrifugal Switch (not shown)		1
	JI-X04-B	Capacitor (motor – not shown)	300MFD 125VAC	1
	JI-X04-CA	Capacitor Cover		1
	JI-X04-DA	Junction Box (motor – not shown)		1
	JI-X04-EA	Junction Box Cover (motor – not shown)		1
	JI-X02-A	Motor Cord (not shown)		1
	JJ6CS-HK	Hardware Kit (not shown)		1
	TS-152704	Hex Key Wrench 3mm (not shown)*	3 mm	1
	JJ6CS-OEW	Open End Wrench 8/10mm (not shown)*	8/10 mm	1
	JJ6CS-OEW2	Open End Wrench 12/14mm (not shown)*	12/14 mm	1
	TS-227D081	Hex Wrench (8mm – not shown)*		1
	JJ6CSDX-326A	T-Hex Wrench (4mm – not shown)*		1
27	JJ6-03CS	Key	5x5x30 mm	1
28	5AL-C10B	Tapping Screw	M4x25	2
30	TS-0680031	Flat Washer	5/16"	4
31	JET-811T	JET Logo (not shown)	8" x 11"	1
32	JJ6CSX-332	Warning Label		1
33	JEB-S07	Warning Label		1
34	JEB-S08	Voltage Label		1
35	JEB-S09	Switch Box		1
36	TS-0720081	Lock Washer	5/16"	4
37	TS-1550021	Flat Washer*	M4	4
38	TS-0803032	Screw*	#5-40x3/8"	4
39	TS-081F032	Screw*	1/4"-20x1/2"	4
40	TS-0680021	Flat Washer*	1/4"	4
41	JEY-S03W	Belt Guard		1
42	JEY-S07	Plate		1
43	TS-081C032	Screw	#10-24x1/2"	2
44	TS-069204	Flat Washer	#10	2
45	TS-0561031	Hex Nut	3/8"-16	1
46	JC-M05	Door Latch		1
47	JC-M04	Knob Screw		1
48	JJ6CSDX-348	Black Stripe (not shown)	90mm x 780mm	2

\* included in Hardware Kit for JJ-6CSDX

15.3.1 Stand Assembly, JJ-6HHDX only – Exploded View

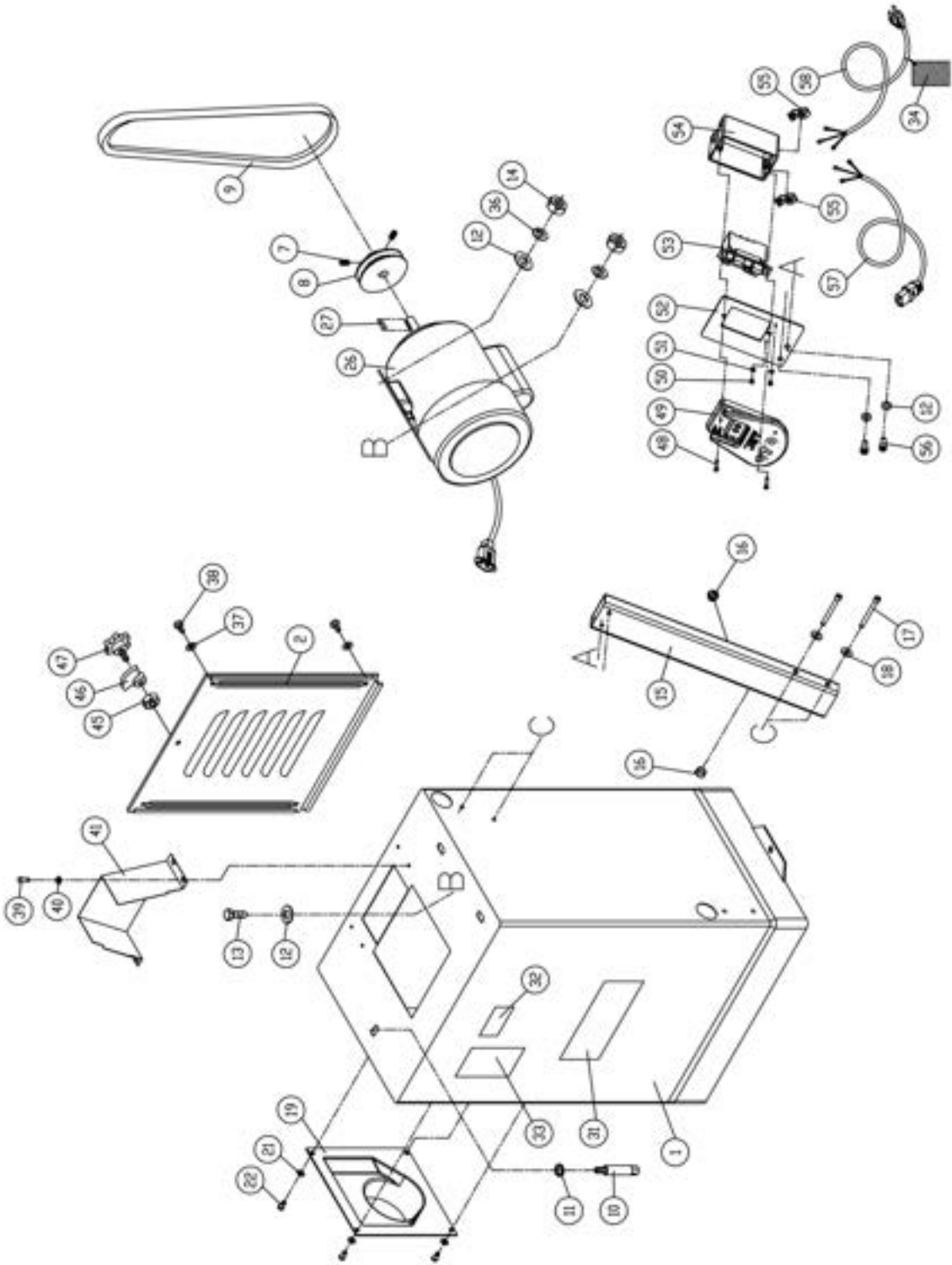

### 15.3.2 Stand Assembly, JJ-6HHDX only – Parts List

Index No.	Part No.	Description	Size	Qty.
1	JJ6HH-301	Stand Body		1
2	JI-Y01AW	Access Cover		1
7	TS-0267041	Set Screw	1/4"-20x3/8"	2
8	6296125	Motor Pulley		1
9	VB-A37	V-Belt	A-37	1
10	JC-M07	Lock Bolt*	3/8"-16	3
11	TS-0720091	Lock Washer*	3/8"	3
12	TS-0680031	Flat Washer	5/16"	10
13	TS-0081031	Hex Cap Screw	5/16"-18x3/4"	4
14	TS-0561021	Hex Nut	5/16"-18	4
15	JJ6HH-315	Switch Arm		1
16	JJ6HH-316	Cord Protector		2
17	TS-0208141	Socket Head Cap Screw*	5/16"-18x3"	2
18	TS-0680031	Flat Washer*	5/16"	2
19	JEX-S02	Dust Chute		1
21	TS-0680021	Flat Washer*	1/4"	4
22	TS-081F032	Screw*	1/4"-20x1/2"	4
26	JI-X04W	Motor	1HP	1
	JI-X04-AA	Centrifugal Switch (not shown)		1
	JI-X04-B	Capacitor (not shown)	300MFD 125VAC	1
	JI-X04-CA	Capacitor Cover		1
	JI-X04-DA	Junction Box (motor – not shown)		1
	JI-X04-EA	Junction Box Cover (motor – not shown)		1
	JI-X02-A	Motor Cord (not shown)		1
	TS-152704	Hex Wrench 3mm (not shown)*	3 mm	1
	TS-152707	Hex Wrench 6mm (not shown)*	6 mm	1
	JJ6CS-OEW	Open End Wrench 8/10mm (not shown)*	8/10 mm	1
	JJ6CS-OEW2	Open End Wrench 12/14mm (not shown)*	12/14 mm	1
27	JJ6-03CS	Key	5x5x30 mm	1
31	JET-811T	JET Logo (not shown)	8" x 11"	1
32	JJ6CSX-332	Caution Label		1
33	JEB-S07	Warning Label		1
34	JEB-S08	Voltage Label		1
36	TS-0720081	Lock Washer	5/16"	4
37	TS-1550021	Flat Washer*	M4	4
38	TS-0803032	Screw*	#5-40x3/8"	4
39	TS-081F032	Screw*	1/4"-20x1/2"	4
40	TS-0680021	Flat Washer*	1/4"	4
41	JEY-S03W	Belt Guard		1
45	TS-0561031	Hex Nut	3/8"-16	1
46	JC-M05	Door Latch		1
47	JC-M04	Knob Screw		1
48	JJ6HH-348	Screw	M4x25	2
49	JPS10TS-342	Stop Switch Face Plate		1
50	TS-2171012	Screw	M4x6	2
51	JJ6HH-351	Star Washer	M4	2
52	JJ6HH-352	Switch Plate		1
53	JPS10TS-343	Main Switch		1
54	JPS10TS-347	Switch Box		1
55	JJ6HH-355	Strain Relief		2
56	TS-0208021	Socket Head Cap Screw	5/16"-18x1/2"	2
57	JJ6HH-357	Motor Cord		1
58	JJ6HH-358	Power Cord		1
59	JJ6HH-113	Star Point Screwdriver (not shown)*		2
	JJ6HH-HK	Hardware Kit (contains items marked with *)		1
	JJ6CSDX-348	JET Stripe (not shown)	90mm	2

\* included in JJ6HH-HK, Hardware Kit



15.4.1 Bed Assembly (All models) – Exploded View

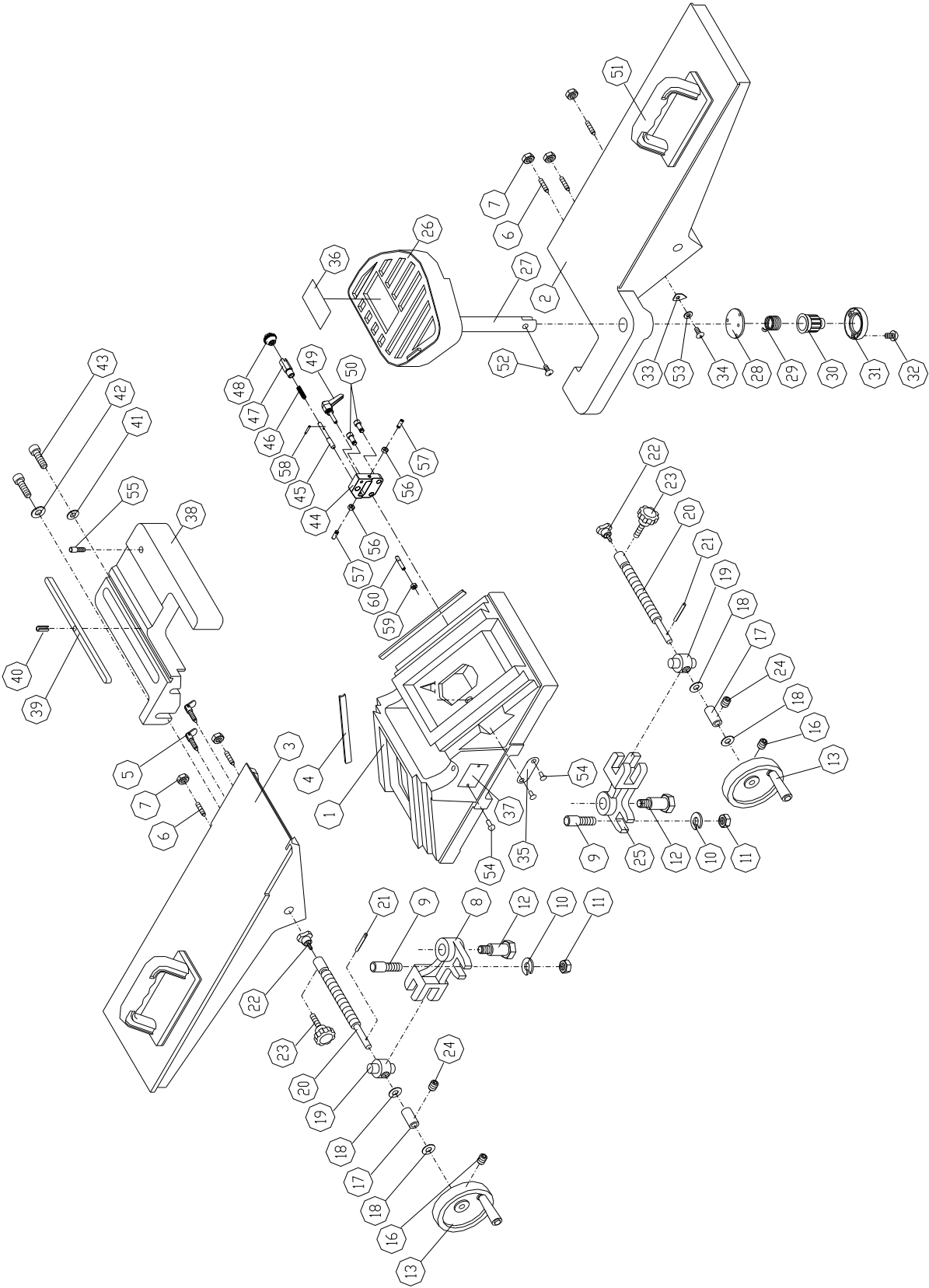

## 15.4.2 Bed Assembly (All models) – Parts List

Index No.	Part No.	Description	Size	Qty.
1	JJ6CSDX-401	Base		1
2	JJ6CSDX-402A	Front Table		1
3	JJ6CSDX-403	Rear Table		1
4	JI-T04	Gib		2
5	JH-T30	Lock Screw		2
6	TS-0267091	Set Screw	1/4"-20x1"	5
7	TS-0561011	Hex Nut	1/4"-20	5
8	JI-T07W	Ball Crank		1
9	JI-T06	Shoulder Pin		2
10	TS-0680061	Flat Washer	1/2"	2
11	PJ882-118	Hex Nut	1/2"-12	2
12	JH-T11	Pivot Pin		2
13	JJ6CSX-413	Handwheel Assembly		2
16	TS-0267041	Set Screw	1/4"-20x3/8"	2
17	JH-T16	Bushing		2
18	JH-T17	Washer		4
19	JH-T18	Adjusting Nut		2
20	JH-T19	Adjusting Screw		2
21	5F-E108	Pin	Ø3x24 mm	2
22	JH-T20	Lock Knob		2
23	JH-T21	Lock Knob		2
24	TS-0270031	Set Screw	5/16"-18x3/8"	2
25	JH-T12W	Ball Crank		1
26	JH-T22	Cutterhead Guard		1
27	JH-T23	Guard Post		1
28	JH-T24	Retaining Washer		1
29	JH-T25	Spring		1
30	JH-T26	Spring Knob		1
31	JH-T27	Retainer		1
32	TS-081B042	Screw	#8-32x5/8"	3
33	JC-T17	Pointer		1
34	TS-081B012	Screw	#8-32x1/4"	1
35	JJ6-19	Depth Scale		1
36	JJ6-01CS	Warning Label		1
37	JJ6CSDX-437	ID Label (JJ-6CSDX)		1
	JJ6HH-437	ID Label (JJ-6HHDH)		1
38	JJ6CSDX-438	Fence Base		1
39	JED-B02	Key		1
40	5FF-J12	Spring Pin	Ø4x20 mm	1
41	TS-0680041	Flat Washer	3/8"	1
42	TS-0680041	Flat Washer	3/8"	1
43	TS-0209071	Socket Head Cap Screw	3/8"-16x1-1/2"	2
44	JJ6CSDX-444	1/8" Set Block		1
45	JJ6CSDX-445	Stud		1
46	JEA-B08	Spring		1
47	JJ6CSDX-447	Stud		1
48	5DF-B05	Knob		1
49	5CO-D09B	Lock Handle	1/4"-20x7/8"	1
50	TS-0208041	Hex Socket Cap Screw	5/16"-18x3/4"	2
51	708815	Push Block		2
52	TS-1533032	Screw	M5x0.8Px10	1
53	TS-1550021	Flat Washer	M4	1
54	5F-H051	Rivet		6
55	TS-0207021	Socket Head Cap Screw	1/4"-20x1/2"	1
56	TS-0561011	Hex Nut	1/4"-20	2
57	TS-0267071	Set Screw	1/4"-20x3/4"	2
58	PJ882-108	Spring Pin	Ø3x20 mm	1
59	TS-0561021	Hex Nut	5/16"-18	1
60	JJ6CSDX-460	Stud		1
61	JJ6CSDX-461	Model Decal (not shown)	JJ6	1

**15.5.1 Cutterhead, JJ-6CSDX – Exploded View**

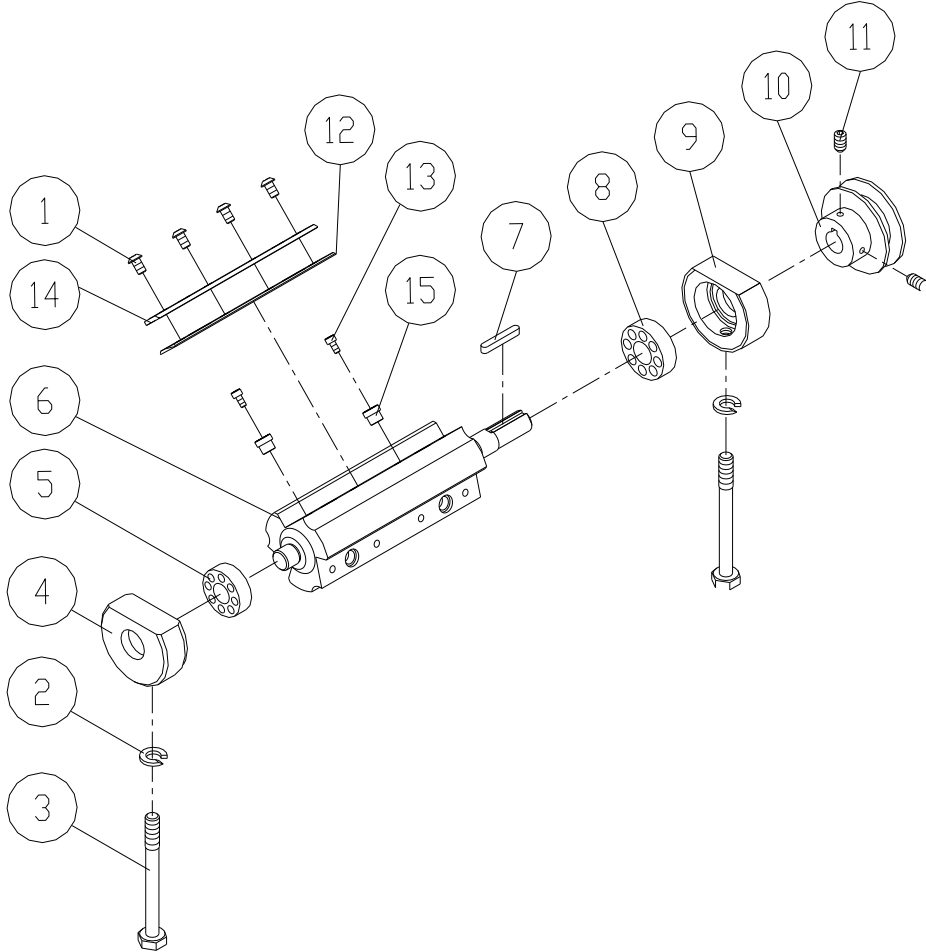

**15.5.2 Cutterhead JJ-6CSDX – Parts List**

Index No.	Part No.	Description	Size	Qty.
	JJ6CSDX-CA	Cutterhead Assembly (Index # 1-15)		1
1	JJ6CSDX-101	Special Button Head Socket Screw		12
2	TS-0720091	Lock Washer	3/8"	2
3	JEA-B01	Bolt		2
4	3H-C02	Bearing Housing		1
5	BB-6202ZZ	Ball Bearing	6202ZZ	1
6	JJ6CSDX-106	Cutterhead		1
7	5F-G108	Key	5x5x25 mm	1
8	BB-6203ZZ	Ball Bearing	6203ZZ	1
9	JH-C04	Bearing Housing		1
10	JH-C07	Cutterhead Pulley		1
11	TS-0267041	Set Screw	1/4"-20x3/8"	2
12	708801DX	Knife for JJ-6CSDX (set of 3)		1
13	TS-1501021	Socket Head Cap Screw	M4-0.7Px8	6
14	JJ6CSDX-114	Knife Lock Bar		3
15	JJ6CSDX-115	Adjustment Nut		6

15.6.1 Cutterhead, JJ-6HHDX – Exploded View

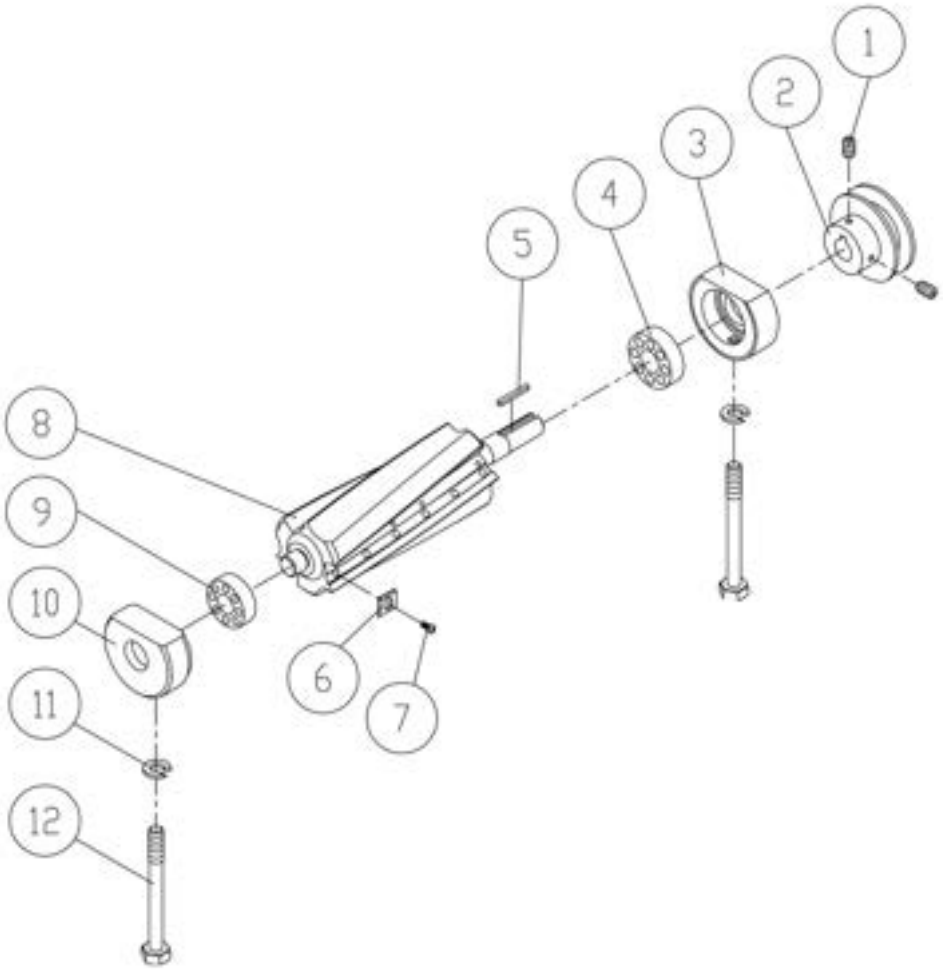

15.6.2 Cutterhead, JJ-6HHDX – Parts List

Index No.	Part No.	Description	Size	Qty.
	JJ6HH-CA	Cutterhead Assembly (Index # 1 thru 12)		1
1	TS-0267041	Socket Set Screw	1/4"-20x3/8	2
2	JH-C07	Cutterhead Pulley		1
3	JH-C04	Bearing Housing		1
4	BB-6203VV	Ball Bearing	6203VV	1
5	5F-G108	Key	5x5x25 mm	1
	1791221-4	Helical Cutterhead Unit (Index # 6 thru 8)		1
6	1791212	Knife Insert (set of 10)		total 27
7	JWP208HH-111	Knife Insert Screw	#10-32x1/2	27
8	JJ6HH-108	Helical Cutterhead		1
9	BB-6202VV	Ball Bearing	6202VV	1
10	3H-C02	Bearing Housing		1
11	TS-0720091	Lock Washer	3/8"	2
12	JEA-B01	Bolt	3/8"-24x3-1/2"	2

16.0 Wiring Diagrams (All Models)

ELECTRICAL SCHEMATIC - 115V

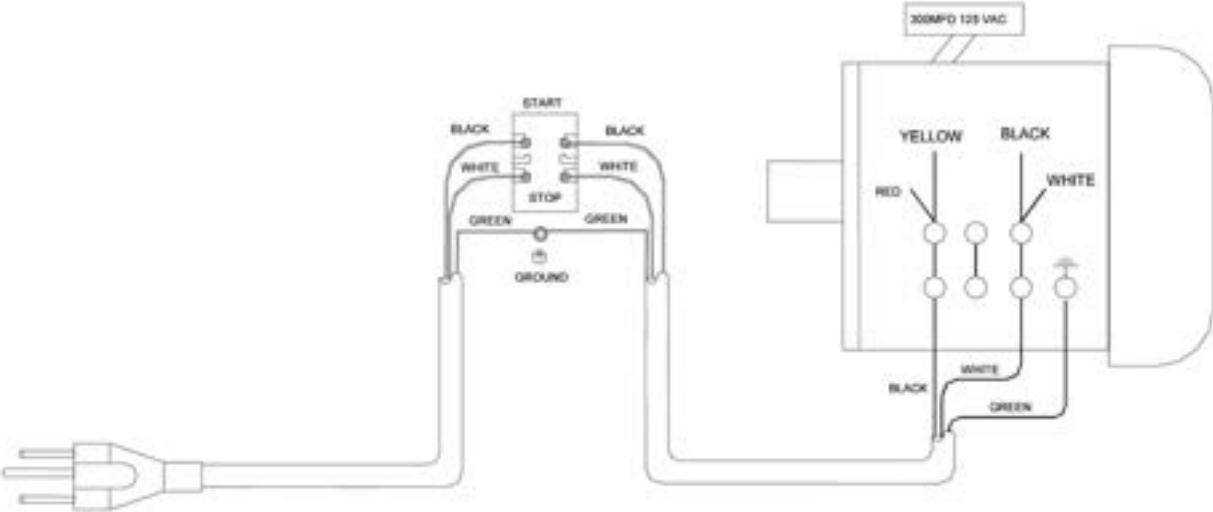

ELECTRICAL SCHEMATIC - 230V

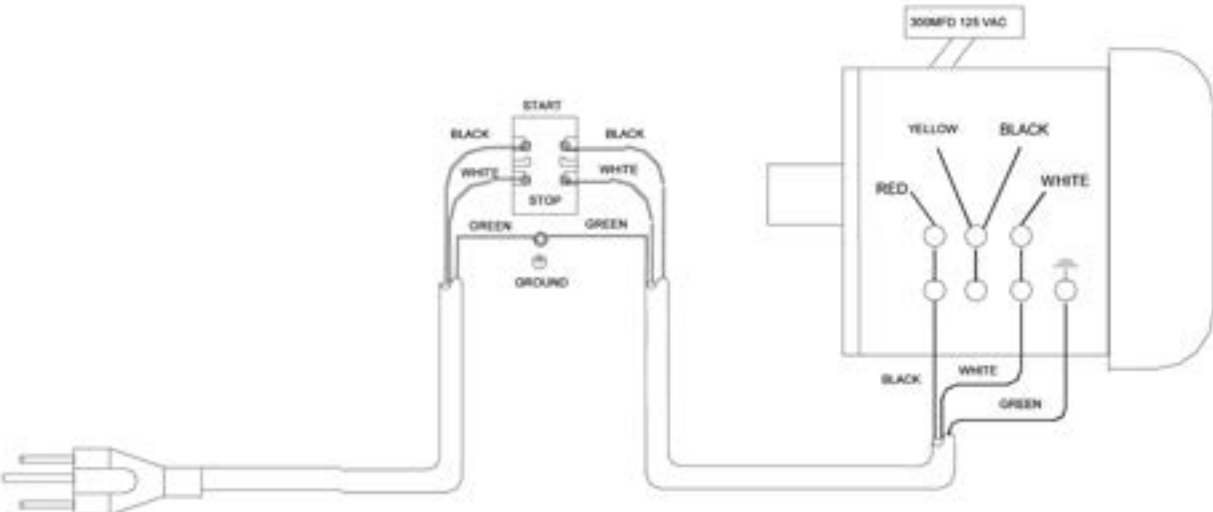

# 17.0 Warranty and Service

JET warrants every product it sells against manufacturers' defects. If one of our tools needs service or repair, please contact Technical Service by calling 1-800-274-6846, 8AM to 5PM CST, Monday through Friday.

### Warranty Period

The general warranty lasts for the time period specified in the literature included with your product or on the official JET branded website.

- JET products carry a limited warranty which varies in duration based upon the product. (See chart below)
- Accessories carry a limited warranty of one year from the date of receipt.
- Consumable items are defined as expendable parts or accessories expected to become inoperable within a reasonable amount of use and are covered by a 90-day limited warranty against manufacturer's defects.

### Who is Covered

This warranty covers only the initial purchaser of the product from the date of delivery.

### What is Covered

This warranty covers any defects in workmanship or materials subject to the limitations stated below. This warranty does not cover failures due directly or indirectly to misuse, abuse, negligence or accidents, normal wear-and-tear, improper repair, alterations, or lack of maintenance. JET woodworking machinery is designed to be used with Wood. Use of these machines in the processing of metal, plastics, or other materials outside recommended guidelines may void the warranty. The exceptions are acrylics and other natural items that are made specifically for wood turning.

### Warranty Limitations

Woodworking products with a Five-Year Warranty that are used for commercial or industrial purposes default to a Two Year Warranty. Please contact Technical Service at 1-800-274-6846 for further clarification.

### How to Get Technical Support

Please contact Technical Service by calling 1-800-274-6846. **Please note that you will be asked to provide proof of initial purchase when calling.** If a product requires further inspection, the Technical Service representative will explain and assist with any additional action needed. JET has Authorized Service Centers located throughout the United States. For the name of an Authorized Service Center in your area call 1-800-274-6846 or use the Service Center Locator on the JET website.

### More Information

JET is constantly adding new products. For complete, up-to-date product information, check with your local distributor or visit the JET website.

### How State Law Applies

This warranty gives you specific legal rights, subject to applicable state law.

### Limitations on This Warranty

JET LIMITS ALL IMPLIED WARRANTIES TO THE PERIOD OF THE LIMITED WARRANTY FOR EACH PRODUCT. EXCEPT AS STATED HEREIN, ANY IMPLIED WARRANTIES OF MERCHANTABILITY AND FITNESS FOR A PARTICULAR PURPOSE ARE EXCLUDED. SOME STATES DO NOT ALLOW LIMITATIONS ON HOW LONG AN IMPLIED WARRANTY LASTS, SO THE ABOVE LIMITATION MAY NOT APPLY TO YOU.

JET SHALL IN NO EVENT BE LIABLE FOR DEATH, INJURIES TO PERSONS OR PROPERTY, OR FOR INCIDENTAL, CONTINGENT, SPECIAL, OR CONSEQUENTIAL DAMAGES ARISING FROM THE USE OF OUR PRODUCTS. SOME STATES DO NOT ALLOW THE EXCLUSION OR LIMITATION OF INCIDENTAL OR CONSEQUENTIAL DAMAGES, SO THE ABOVE LIMITATION OR EXCLUSION MAY NOT APPLY TO YOU.

JET sells through distributors only. The specifications listed in JET printed materials and on official JET website are given as general information and are not binding. JET reserves the right to effect at any time, without prior notice, those alterations to parts, fittings, and accessory equipment which they may deem necessary for any reason whatsoever. JET® branded products are not sold in Canada by JPW Industries, Inc.

### Product Listing with Warranty Period

90 Days – Parts; Consumable items
1 Year – Motors; Machine Accessories
2 Year – Metalworking Machinery; Electric Hoists, Electric Hoist Accessories; Woodworking Machinery used for industrial or commercial purposes
5 Year – Woodworking Machinery
Limited Lifetime – JET Parallel clamps; VOLT Series Electric Hoists; Manual Hoists; Manual Hoist Accessories; Shop Tools; Warehouse & Dock products; Hand Tools; Air Tools

NOTE: JET is a division of JPW Industries, Inc. References in this document to JET also apply to JPW Industries, Inc., or any of its successors in interest to the JET brand.



427 New Sanford Road  
LaVergne, Tennessee 37086  
Phone: 800-274-6848  
[www.jettools.com](http://www.jettools.com)